

8 7 6 5 4 3 2 1

D  
C  
B  
A

D  
C  
B  
A

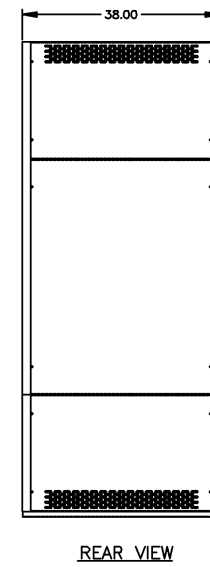
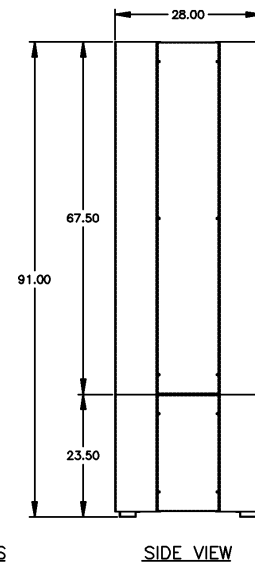
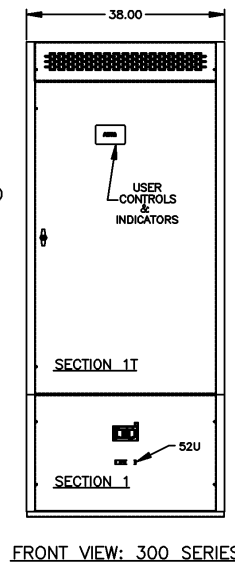
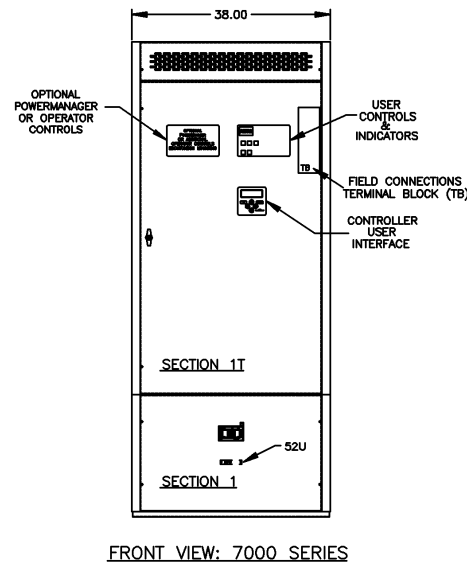
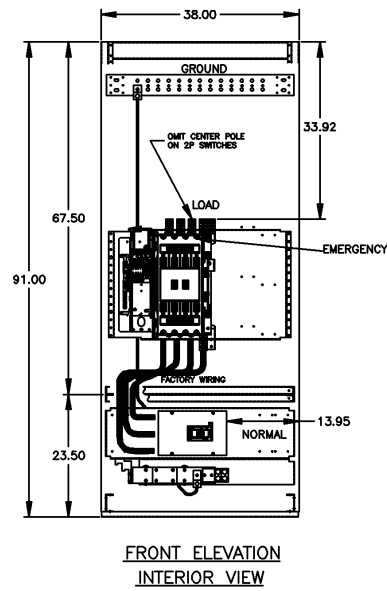
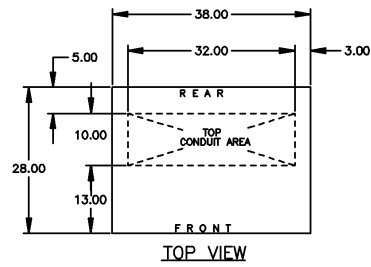

ONE LINE DIAGRAMS

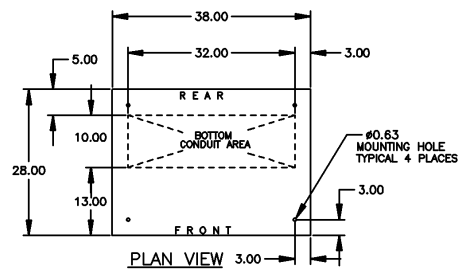
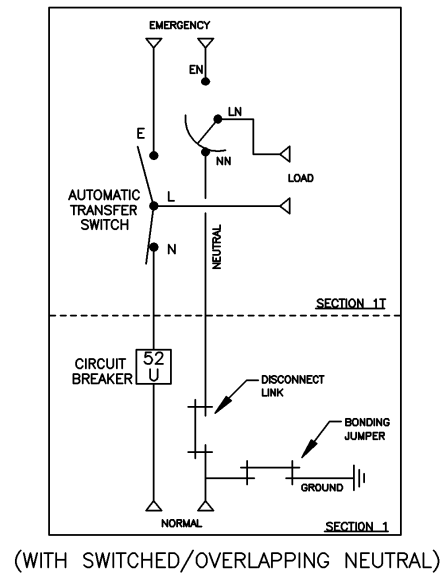
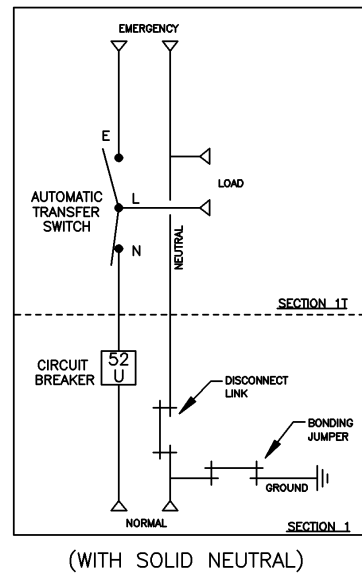

GENERAL NOTES

- TYPE 1 ENCLOSURE. FREE STANDING. FLOOR MOUNTED. CODE GAUGE STEEL.
- ALL DOORS HAVE LOCKABLE HANDLES WITH COMMON KEYING AND CAPTIVE SCREWS AS REQUIRED.
- FINISH: ANSI 61 GRAY POLYESTER SEMI GLOSS ELECTROSTATIC POWDER.
- RECOMMENDED CLEARANCES:  
FRONT: 38 INCHES
- ALL BUS IS SILVER-PLATED COPPER, BASED ON 1000A PER SQ. IN. DENSITY.
- A FULL RATED NEUTRAL CONNECTION FOR EACH SOURCE AND THE LOAD IS OPTIONAL. WHEN PROVIDED IT IS IN ONE OF THE FOLLOWING FORMATS AS SPECIFIED BY THE CATALOG NO. NEUTRAL TYPE:  
A. SOLID (COPPER BUS) NEUTRAL (SHOWN) (PROVIDED STANDARD ON H3AUS)  
B. SWITCHED NEUTRAL POLE  
C. OVERLAPPING NEUTRAL POLE (NOT AVAILABLE ON 7ACUS/7ADUS UNITS)
- DESIGNED FOR FRONT ACCESS
- FOR SPECIFIED TRANSFER SWITCH, REFER TO OPERATOR'S MANUAL PROVIDED WITH UNIT.
- SECTION 1 & SECTION 1T SHIP AS 1 UNIT.

SPECIFICATIONS

- SERVICE VOLTAGE:  
SYSTEM RATING: 450 AMPS, 500 AMPS, 600 AMPS, 3 $\phi$ , 4W OR 1 $\phi$ , 3W.  
GROUND BUS- 200 AMPS  
SHORT CIRCUIT RATING- 50,000 RMS SYM AMPERES @ 480V, 65,000 RMS SYM AMPERES @ 240V  
THE EMERGENCY SOURCE INPUT MUST BE PROTECTED BY A REMOTE OVERCURRENT PROTECTION DEVICE AS LISTED ON THE MARKINGS ON THE TRANSFER SWITCH.
- BATTERY VOLTAGE: N/A
- NEUTRAL BUS: 600 AMPS
- APPLICABLE LABELS: U.L. 891- SUITABLE ONLY FOR USE AS SERVICE EQUIPMENT.

CABLING NOTES

- ALL SIZES SUPPLIED STANDARD WITH MECHANICAL (SCREW TYPE) LUGS. (SEE AMP SIZE BELOW)  
A. LUG MATERIAL: ALUMINUM ALLOY 6061-T6 WITH ELECTRO TIN PLATED FINISH.  
B. SCREW MATERIAL: ALUMINUM ALLOY 6262-T9 WITH ELECTRO TIN PLATED FINISH.  
C. UL LISTED, CSA CERTIFIED.  
D. LUG SCREW TIGHTENING TORQUE PER UL 486B: 19 FT-LBS.  
E. SUITABLE WIRE BENDING SPACE IS PROVIDED. (SEE AMP SIZE BELOW)
- OPTIONAL COPPER CRIMP LUGS MAY BE SUPPLIED. (SEE AMP SIZE BELOW)  
A. LUG MATERIAL: HIGH CONDUCTIVITY WROUGHT COPPER FINISH, ELECTRO TIN PLATED.  
B. UL LISTED, CSA CERTIFIED.  
C. LUG MOUNTING HARDWARE TIGHTENING TORQUE: (REFER TO WITHSTAND CURRENT RATING LABEL PROVIDED ON EACH TRANSFER SWITCH).  
D. SUITABLE WIRE BENDING SPACE IS PROVIDED. (SEE AMP SIZE BELOW)
- CONSULT FACTORY FOR OTHER TERMINATION REQUIREMENTS.

NOTES 450-600 AMPS

- SUPPLIED WITH STANDARD MECHANICAL (SCREW TYPE) LUGS ON THE EMERGENCY & LOAD BUS STABS. ONE (1) LUG PER PHASE AND NEUTRAL EACH SUITABLE FOR CONNECTION OF TWO (2) #2 AWG-600MCM CU/AL CABLE (SEE NOTE "A" BELOW).  
A. SUITABLE WIRE BENDING SPACE IS PROVIDED FOR UP TO TWO (2) 600MCM CABLES PER TERMINAL PER NEC.
- OPTIONAL COPPER CRIMP LUGS MAY BE SUPPLIED. UP TO TWO (2) TWO HOLE, LONG BARREL CU CRIMP LUGS RATED FOR UP TO 600MCM. (REFER TO CRIMP LUG INSTALLATION DATA PROVIDED WITH UNIT FOR FULL INSTALLATION DETAILS).  
A. SUITABLE WIRE BENDING SPACE IS PROVIDED FOR UP TO TWO (2) 600MCM CABLES PER TERMINAL PER NEC.
- GROUND LUGS ARE PROVIDED STANDARD AS FOLLOWS:  
(B) 1/0 - 750MCM CU/AL CABLE
- NORMAL CABLE CONNECTIONS SUITABLE FOR (3) 3/0 AWG TO 500 MCM PER  $\phi$  AND NEUTRAL.

CIRCUIT BREAKER: ITEM 52U

SQUARE "D" 80% RATED, TYPE "MIL", 800AF/450AT, 800AF/500AT, 800AF/600AT  
MOLDED CASE, ELECTRONIC TRIP.

PROJECT NAME:		225672	SV	RN	01/05/10
REV. TO SHEET	SV	EDN NO.	BY	APP.	DATE
OUTLINE		MOUNTING			
IAUS 450A - 600A, MIL SERVICE ENTRANCE BREAKER					
TYPE 1 91 X 38 X 28					
BY	DATE	MANUFACTURING TOLERANCES TO BE IN ACCORDANCE WITH ASCO PROCEDURE MP-1-003. FOR PLASTIC PARTS SEE MP-1-005		ASSEM. REF. NO.	COMPUTER GENERATED DRAWING
SV	01/04/10				SCALE 1:1 SIZE DS
CHECKED		PROPERTY OF ASCO POWER TECHNOLOGIES. USE PERMITTED FOR OUR WORK ONLY. ALL RIGHTS OF DESIGN OR INVENTION ARE RESERVED.		DWG. NO.	882678-001
PROJECT APPROVAL		ASCO		ASCO POWER TECHNOLOGIES, L.P.	DRAWING REV. -
FINAL APPROVAL		FLORHAM PARK, NEW JERSEY 07932 U.S.A.		REV. NO.	225672
					SHEET 1 OF 1