

# User Manual Operator Level

## Controller

### APM303

Soft version : 2.0.0  
26/02/2016

33508000401\_2\_1

- The "user level" user manual is designed for users who are qualified to set up an installation (generating set and environment). These users must be able to monitor that the generating set is operating correctly (start, stop, basic settings), to interpret any indications (mechanical, electrical) and may be required to check one or more parameters.
- The "operator level" user manual is designed for those who – in addition to the skills required for users – have the skills required to modify one or more parameters, to change the operation of an installation (generating set and environment). To do this, the operator will have completed training provided by the manufacturer beforehand.
- The "specialist level" user manual is designed for those who – in addition to the skills required for operators – have the skills required to make any special or complex modification to an installation (generating set and environment). To do this, the specialist will have completed training provided by the manufacturer beforehand.

# CONTENTS

<b>1</b>	<b>Preface</b>	<b>3</b>
1.1	Safety/Operating conditions/Powering on	3
1.2	Integrating the APM303 in its environment	3
1.3	Who is this manual intended for?	3
<b>2</b>	<b>Identification of the modules</b>	<b>4</b>
2.1	APM303 module	4
2.2	CAN display module	4
<b>3</b>	<b>Powering up the APM303 and associated configurations</b>	<b>4</b>
3.1	Single generator	4
3.2	Generating set with Automatic Transfer Switch	4
<b>4</b>	<b>General description of the APM303 module</b>	<b>5</b>
<b>5</b>	<b>Selecting the operating mode</b>	<b>5</b>
5.1	MANU mode	5
5.2	AUTO mode	6
5.3	During operation	6
<b>6</b>	<b>Display of data</b>	<b>7</b>
6.1	Main, screen 1	7
6.2	Electrical values, screens 2 and 3	7
6.3	Mechanical values, screen 4	7
6.4	Metering, screen 5	8
6.5	Events and anomalies, screen 6	8
6.6	INIT, screen 0	8
<b>7</b>	<b>Events and anomalies</b>	<b>9</b>
7.1	Events	9
7.2	Anomalies	9
7.2.1	Appearance of an alarm	9
7.2.2	Clearing an alarm	9
7.2.3	Alarm chart	10
7.2.4	Appearance of a fault	10
7.2.5	Clearing a fault	10
7.2.6	Fault chart	11
7.2.7	Other anomaly displays	11
<b>8</b>	<b>Settings</b>	<b>12</b>
8.1	Home screen	12
8.2	Accessing settings (Main menu)	12
8.3	Available screens	12
8.4	"Basic settings" screen	13
8.5	"Engine safety features and parameters" screen	13
8.6	"Alternator safety features" screen	13
8.7	"Modbus communication" screen	14
8.8	"Output settings" screen	14
8.8.1	Selecting an output	14
8.8.2	Selecting the "output code"	14
8.8.3	Selecting the output action type	14
8.8.4	Confirming the output	15
8.9	"Input settings" screen	15
8.9.1	Selecting an input	15
8.9.2	Selecting the "input code"	15
8.9.3	Selecting the input action type	15
8.9.4	Confirming the input	16
8.10	"Miscellaneous information" screen	16
8.11	Setting principle in other screens	16
<b>9</b>	<b>Connections</b>	<b>17</b>
9.1	Rear panel connections	17
9.2	K6 connector/voltage measurement	17
<b>10</b>	<b>Technical specifications</b>	<b>18</b>
<b>11</b>	<b>Packaging, storage and handling of the modules</b>	<b>19</b>
11.1	Packaging	19
11.2	Storage	19
11.3	Handling	19
11.3.1	Module packed in its box	19
11.3.2	Module not packed in its box	19

**List of figures**

Figure 1 - integration of the APM303 .....3  
Figure 2 - front panel of the APM303 .....5  
Figure 3 - viewing data .....7  
Figure 4 - main .....7  
Figure 5 - current and voltage .....7  
Figure 6 - outputs .....7  
Figure 7 - mechanical values .....7  
Figure 8 - meters .....8  
Figure 9 - events and anomalies .....8  
Figure 10 - navigating through the stack .....8  
Figure 11 - information available on screen 6 .....8  
Figure 12 - INIT .....8  
Figure 13 - appearance of an alarm .....9  
Figure 14 - appearance of a fault .....10  
Figure 15 - an alarm displayed on the measurements screen .....11  
Figure 16 - main menu .....12  
Figure 17 - setting principle .....16  
Figure 18 - rear panel and connections .....17  
Figure 19 - three phase 3P+N (4 wires) .....17  
Figure 20 - three phase 3P (3 wires) .....17  
Figure 21 - two phase 2P+N (3 wires) .....17  
Figure 22 - single phase 1P+N (2 wires) .....17  
Figure 23 - stored flat .....19  
Figure 24 - stored at an angle .....19  
Figure 25 - antistatic plastic bag .....19



# 1 Preface

The **APM303** is a instrumentation and control system for generating sets. It enables a generating set (whether or not it is connected to an automatic transfer switch) to be started and stopped, and manages the main safety devices for running a generating set.

Easy navigation between the various screens enables rapid display of all the data recorded (mechanical and electrical values). There are only three buttons associated with the generating set's PLC, making it easier to operate the generating set.

## 1.1 Safety/Operating conditions/Powering on

### ■ Safety

	The <b>APM303</b> uses <b>voltage sources of different origins, which are set to potentials dangerous to the human body</b> . For this reason, only qualified personnel are authorised to start up and use the <b>APM303</b> . Before reading this document, we strongly recommended that you read the safety instructions relating to starting up a generating set (see <b>General and Safety Instructions</b> ). SDMO Industries shall not be held responsible for failure to observe any of the instructions described in this manual.	
<b>DANGER</b>		

### ■ Operating conditions

The conditions for use are given at the end of this manual (section '*Technical specifications*'). If a component of the equipment must be replaced, it is necessary to pay attention to the effects of electrostatic discharges (consult the rules for handling given in section '*Handling*').

	The <b>APM303</b> has been factory configured for your application. Any change to the parameters may alter or render unstable the behaviour of your generating set and the installation.
<b>IMPORTANT</b>	

### ■ Powering on

Powering on is specific to the electrical equipment within which the **APM303** is integrated. It is therefore necessary to consult the wiring diagram for the equipment provided with this manual, before powering on.

## 1.2 Integrating the APM303 in its environment

The **APM303** is integrated into central console equipment (type S1500, S2500, S3500, S4500), fitted on the base frame of the generating set, on versions **II** and **IV** (enclosure).



Figure 1 - integration of the APM303

## 1.3 Who is this manual intended for?

This manual is intended for users and operators.

- The user must be qualified to start the generating set. The user must be capable of monitoring the generator to ensure it is running correctly, and be able to interpret the electrical and mechanical indications provided in real time on the different screens. He or she may have to check one or more parameters.
- The operator - in addition to having the skills required for users - has the skills required to modify one or more parameters, to change the operation of an installation. To do this, the operator will have completed training provided by SDMO Industries beforehand.



*Note: for the **APM303**, no distinction is made between the user and the operator. This means that a user can modify all the internal parameters (no access code in the **APM303**).*

*A self-study training aid is also available on our online Gaïa platform, however SDMO can provide any additional training required.*

## 2 Identification of the modules

### 2.1 APM303 module



### 2.2 CAN display module

For generating sets fitted with an ECU, a CAN bus display is used to show engine data.

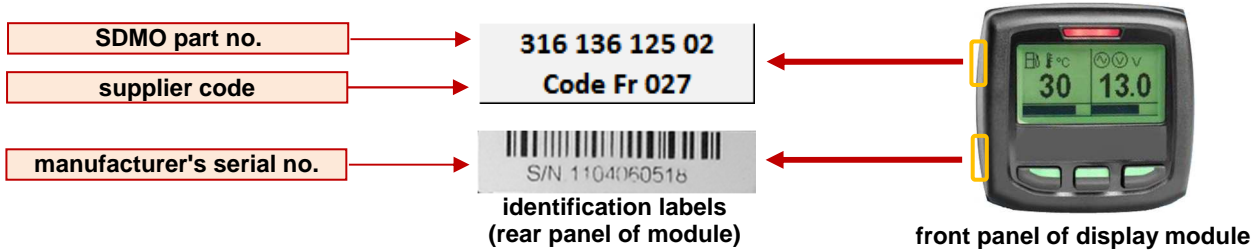

The CAN display module user manual is available on the online Gaïa platform.

## 3 Powering up the APM303 and associated configurations

Depending on the control option chosen, the **APM303** is powered up:

- immediately, as soon as the generating set battery is connected (+ possible closing of battery isolator),
- following a change in the position of the **0/1** switch, located on the front of the central console.

On powering up, the **APM303** automatically runs in the operating mode which was pre-set before it was switched on (see section 'Selecting the operating mode').

### 3.1 Single generator

- The installation comprises:
  - a generating set,
  - an **APM303** and a CAN display (depending on the motor type),
  - a manually controlled circuit breaker.
- This installation supplies a **LOAD** either to:
  - an item of electrical equipment (engine/motor, etc.),
  - an entire building (industrial or service sector).

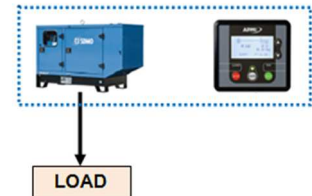

### 3.2 Generating set with Automatic Transfer Switch

- The installation comprises:
  - a generating set,
  - an electrical network,
  - an **APM303** and a CAN display (depending on the motor type),
  - a manually controlled circuit breaker,
  - an automatically controlled Automatic Transfer Switch (\*),
  - a 2-wire connection between the ATS and the generating set for the remote start order.

(\*) automatically controlled: management of the mains power voltage and switching between sources

- This installation supplies a **LOAD** either to:
  - an item of electrical equipment (engine/motor, etc.),
  - an entire building (industrial or service sector).

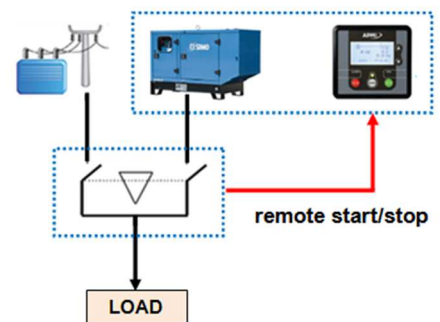

## 4 General description of the APM303 module

The **APM303** consists of a moulded unit measuring 118 x 108.

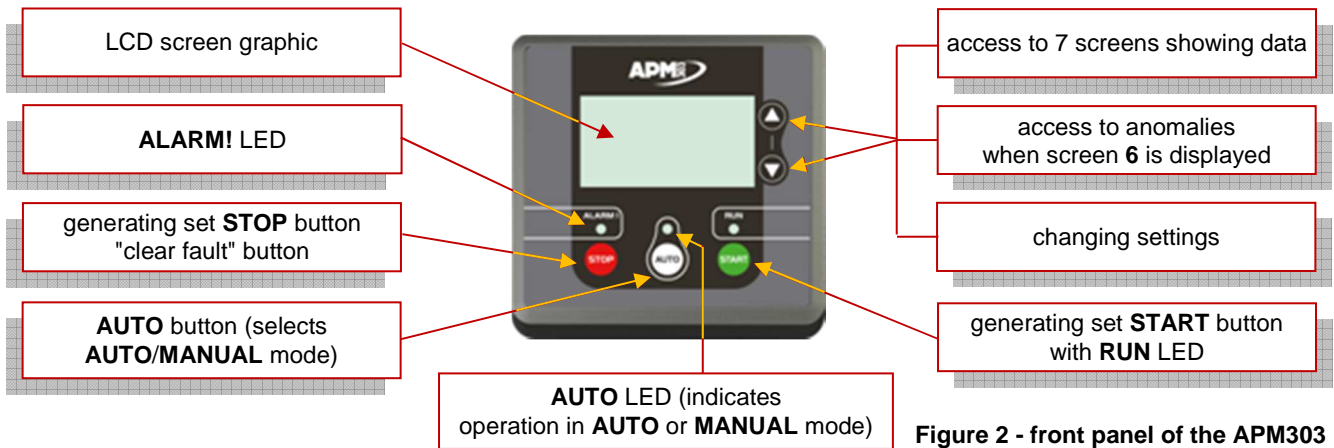

Figure 2 - front panel of the APM303

The technical specifications of the **APM303** are given in section 'Technical specifications'.

## 5 Selecting the operating mode

Two operating modes are available:

- Manual mode (**MANU** mode),
- Automatic mode (**AUTO** mode).

In all the explanations which follow, the terms **MANU** and **AUTO** will be used.

### 5.1 MANU mode

In this mode, the user has full control of generating set using the 2 **START** and **STOP** buttons.

- ⚠ . If a fault is detected (**ALARM!** LED flashing), it is not possible to start up the generating set in **MANU** mode.
- ⚠ . If there is an alarm (**ALARM!** LED flashing), it is still possible to start up the generating set in **MANU** mode. (see section 'Anomalies' for fault or alarm management)

#### Running the generating set

- Pressing the **START** button (START) automatically launches the starting sequence (preheating (\*) + starter), the **RUN** LED flashes (\*\*).
- When the voltage and speed have stabilised (**APM303** internal parameters), the **RUN** LED becomes fixed.
- ⚠ Manually close the generating set's circuit breaker by switching the control lever on the genset.
- The generating set generates or is ready to generate during use (\*\*\*)
- Check the electrical and mechanical values on the various screens of the **APM303** (see section 'Display of data').

(\*) Preheating is not available for all engines.

(\*\*) If the generating set fails to start after the starting sequence, the **RUN** LED goes off, the **ALARM!** LED flashes, and the "fail to start" fault is recorded in the anomalies stack (see section 'Events and anomalies, screen 6' and 'Fault chart').

(\*\*\*) Users may have to manually close one or more auxiliary circuit breakers.

#### Stopping the generating set

- ⚠ If possible, to avoid a sudden increase in frequency when manually tripping a circuit breaker, remove the load progressively, by breaking the terminal circuits one after another.
- ⚠ Manually open the generating set's circuit breaker by switching the control lever on the genset. The load on the generating set is immediately cut off.
- Allow the engine to cool, allowing it to run off load for 3 minutes.
- Press the **STOP** button (STOP), the generating set stops immediately, the **RUN** LED goes off.

#### Special note on manual mode

- When **MANU** mode is selected (**AUTO** LED off), if there is a remote start order (activation of the "remote start/stop" input, nothing happens, the **APM303** remains in **MANU** mode, but the **AUTO** LED flashes to signal that there is a remote order. When the remote order disappears, the **AUTO** LED goes off.

This standard operation is called "priority **MANU** mode". It is possible to switch to "priority **AUTO** mode" (see section "Basic settings" screen', parameter **B16**).

## 5.2 AUTO mode



In this operating mode, the user does not control the operation of the generating set, the starting and stopping of the generating set are dependent on the **APM303** receiving a remote order.

. If a fault is detected (**ALARM!** LED flashing), it is possible to select **AUTO** mode, but it is not possible to start up the generating set in manual mode.



. If there is an alarm (**ALARM!** LED flashing), it is possible to select **AUTO** mode and start up the generating set in manual mode.

(see section 'Anomalies' for fault or alarm management)

- Check that the generating set circuit breaker is closed. Alternatively,  switch the circuit breaker control lever.
- Press the **AUTO** button () , the **AUTO** LED lights up, **AUTO** mode is selected. The generating set is on standby, ready to start.

Automatic start-up is dependent on activation of the "remote start/stop" input.



This input must be a potential-free contact (\*), this means that the user must not connect an external power supply to the terminals provide for this purpose. This will destroy the **APM303**.

(\*) In general, the external input comes from an automatically controlled ATS.

An automatically controlled ATS independently controls the mains supply (power connection and disconnection), sends the start order to the generating set and ensures switching in both directions; Normal⇒Emergency and Emergency⇒Normal.

- When the "remote start/stop" input is activated, the **RUN** LED flashes, the generating set starts immediately (sequence launch). When the voltage and frequency have stabilised on the alternator terminals, the **RUN** LED becomes fixed and the generating set takes over.

- When the "remote start/stop" input is deactivated, the **RUN** LED flashes again, the generating set enters the cooling phase (3 minutes).



Where an ATS is fitted, cooling periods may accumulate. In fact, cooling can also be taken into account in the changeover switch.

- When cooling is complete, the **RUN** LED goes off and the generating sets stops.
- The **AUTO** LED remains on, the generating set is on standby, ready for another start.

### Special note on AUTO mode



• When **AUTO** mode is selected and the generating set is on standby, pressing the **START** button () immediately starts the generating set (**AUTO** mode is deactivated).

• Is the generating set is already running, pressing the **START** button () deactivates **AUTO** mode operation. The **APM303** switches to **MANU** mode, the generating set continues to generate.



• When the "remote start/stop" input disappears, the generating sets continues to operate as the user has switched to **MANU** mode.



• When the generating set is operating, pressing the **STOP** button () deactivates **AUTO** mode and immediately stops the generating set, without cooling.

This standard operation is called "priority **MANU** mode". It is possible to switch to "priority **AUTO** mode" (see section "Basic settings" screen', parameter **B16**).

In priority **AUTO** mode, pressing the **START** () and **STOP** () buttons does not change the status of the generating set.

## 5.3 During operation

• Monitor the electrical values on screens **4**, **5** and **6** (see section 'Display of data'), and particularly the current flow.



Never exceed a nominal power indicated on the alternator's rating plate.

• Monitor the mechanical values on screens **7** and **8** (see section 'Display of data') and particularly the coolant temperature.

• When the generating set is operating (**RUN** LED lit), in **AUTO** mode (**AUTO** LED lit) or in **MANU** mode (**AUTO** LED off), the appearance of an alarm does not modify the operation of the generating set.

(see sections 'Events and anomalies, screen 6' and 'Anomalies' on alarm management)

• When the generating set is operating (**RUN** LED lit), in **AUTO** mode (**AUTO** LED lit) or in **MANU** mode (**AUTO** LED off), the appearance of a fault immediately stops the generating set.

(see sections 'Events and anomalies, screen 6' and 'Anomalies' on fault management)



## 6 Display of data

To view the data measured and recorded by the **APM303**, the user has 6 or 7 screens available:

- 7 screens are automatically displayed one after the other, with a delay of 7 seconds,
- 6 screens are displayed by successively pressing the **▼** button (successively pressing the **▲** button reverses the cycle shown in the diagram below).

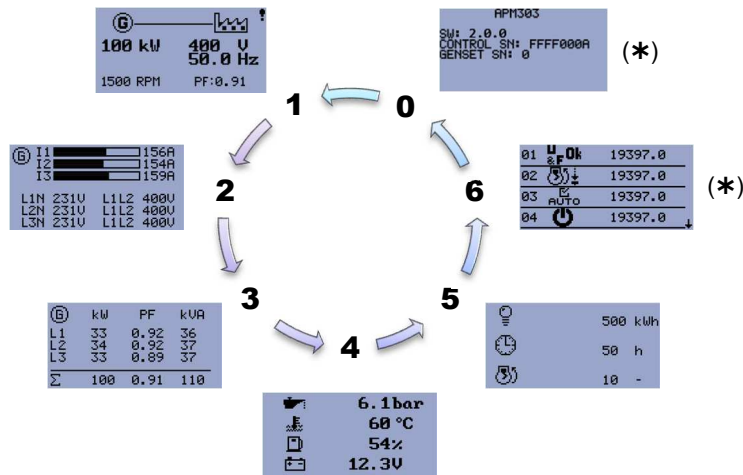

(\*) is only shown automatically if:

- an alarm is active,
- or a fault is active (cleared or not),
- or fault inactive and not cleared.

Automatic screen scrolling begins 2 minutes after the module is powered up.

Automatic screen scrolling is stopped by pressing **▼** or **▲**. It restarts automatically 2 minutes after being pressed.

Figure 3 - viewing data

### 6.1 Main, screen 1

On powering up and after the initialisation period, this is the screen which is displayed by default. The following information is displayed on screen 1:

- power supplied in kW (e.g.: **100kW**),
- the voltage between phases in Volts (e.g.: **400V**),
- the voltage frequency in Hertz (e.g.: **50Hz**),
- The generating set speed in rpm (e.g.: **1500rpm**),
- the power factor (e.g.: **0.91**).



Figure 4 - main

### 6.2 Electrical values, screens 2 and 3

The following information is displayed on screen 2:

- current in each phase in Amps (e.g.: **156, 154 and 159A**), (the bar graph gives an indication of the percentage current supplied compared with nominal current)
- the 3 voltages between phase and neutral in Volts (e.g.: **231V**),
- the 3 voltages between phases in Volts (e.g.: **400V**).

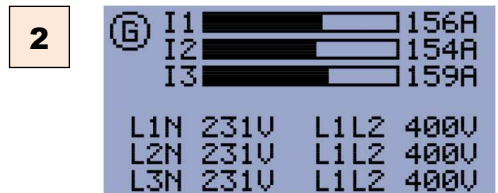

Figure 5 - current and voltage

The following information is displayed on screen 3:

- the power supplied to each phase in kW (e.g.: **33, 34 and 33kW**),
- the power supplied to each phase in kVA (e.g.: **36, 37 and 37kVA**),
- the power factor on each phase (e.g.: **0.92, 0.92 and 0.89**).
- the sum of the 3 active power values in kW (e.g.: **100kW**),
- the sum of the 3 apparent power values in kVA (e.g.: **110kVA**),
- the average power factor (e.g.: **0.91**).

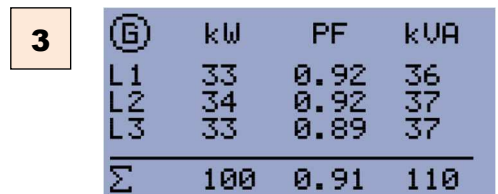

Figure 6 - outputs

### 6.3 Mechanical values, screen 4

The following information is displayed on screen 4:

- the oil pressure in bar or in PSI (\*) (e.g.: **6.1bar**),
- the coolant temperature in °C or °F ( \*) (e.g.: **60°C**),
- the percentage of fuel left in the tank (e.g.: **54%**),
- the battery voltage in Volts (e.g.: **12.3V**).

(\*) depending on settings

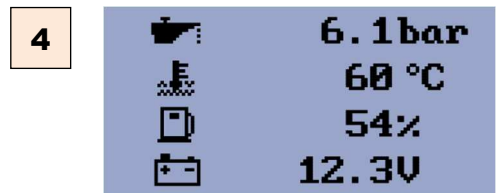

Figure 7 - mechanical values

## 6.4 Metering, screen 5

The following information is displayed on screen 5:

- active energy in kWh (e.g.: **500kWh**).
- the number of operational hours of the generating set (e.g.: **50h**),
- the number of generating set start-ups (e.g.: **10**).



5		500 kWh
		50 h
		10 -

Figure 8 - meters

## 6.5 Events and anomalies, screen 6



Screen 6 shows the list of events and anomalies recorded by the **APM303**. A maximum of 12 events and anomalies can be recorded (the last 4 appear on screen).

Consequently, when a new event or anomaly is recorded, the oldest event or anomaly is deleted from the stack.

6	01		19397.0
	02		19397.0
	03		19397.0
	04		19397.0

Figure 9 - events and anomalies

When scrolling (manually or automatically), the symbol ↓ appears at the bottom of the screen (flashing) for 4 seconds.

- When the symbol is fixed, pressing button  enables you to go down the stack of events and anomalies according to the following principle.
- When the  button is first pressed, the ↑, symbol appears to show that there are more recent events or anomalies on this screen.

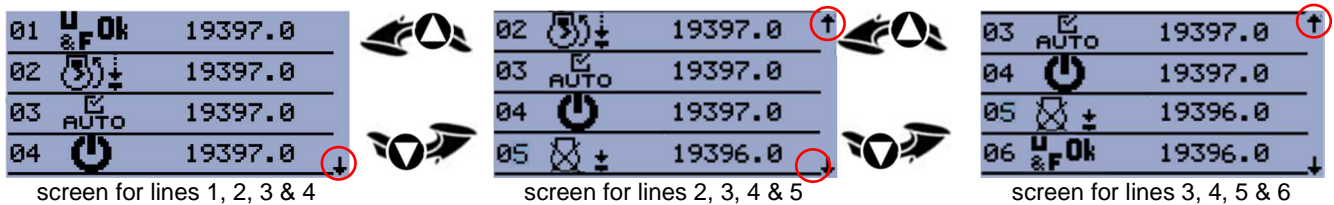

Figure 10 - navigating through the stack

You can continue navigating in this way, until the screen for lines 9, 10, 11 & 12 is displayed.

### Information available on these screens:

- A the event or anomaly appears in numerical order (01 to 12)
- B pictogram representing the event or anomaly (see lists in section 'Events and anomalies')
- C anomaly status (4 different statuses) (see section 'Clearing a fault')
- D number of hours generating set has been operating when event or anomaly appeared

A	01		19399.0	C
	02		19397.0	
B	03		19397.0	D
	04		19397.0	

Figure 11 - information available on screen 6

## 6.6 INIT, screen 0

Screen 0 displays the main identification parameters:

- the software number,
- the serial number of the **APM303** module,
- the generating set serial number.

0	APM303	
	SW: 2.0.0	
	CONTROL SN: FFFF000A	
	GENSET SN: 0	

Figure 12 - INIT

## 7 Events and anomalies

### 7.1 Events

An event is either a change in **APM303** status (powering up), or activation of one the 3 buttons, or any change in the PLC status (e.g. start-up).

The table below lists all the events which can be recorded in the stack.

symbol	description
	The <b>APM303</b> is powered up: the unit is powered up either when the battery is connected, or when the switch on the front panel is set to position 1.
	Starting up in <b>MANUAL</b> mode: the generating set has been started manually, after pressing button
	Starting up in <b>AUTO</b> mode: the <b>APM303</b> is in <b>AUTO</b> mode and the generating set has been started up after activation of the external input, terminal <b>T10</b> (I02 remote start/stop).
	Stopping in <b>MANUAL</b> mode: the generating set has been stopped manually, after pressing button
	Stopping in <b>AUTO</b> mode: the <b>APM303</b> is in <b>AUTO</b> mode and the generating set has been stop after deactivation of the external input, terminal <b>T10</b> (I02 remote start/stop).
	<b>AUTO</b> mode has been activated: the unit recognises that the  button has been pressed, the <b>AUTO</b> LED light is fixed, the generating set can start up on activation of the "remote start/stop" input (terminal <b>T10</b> ).
	<b>AUTO</b> mode has been deactivated: the unit recognises that the  button has been pressed, the <b>AUTO</b> LED is off, the generating set cannot start up on activation of the "remote start/stop" input (terminal <b>T10</b> ).
	Generating set stabilised (ready to generate): This event is recorded if the minimum stabilisation time has elapsed and if electrical parameters U and F are within the setting range.
	Automatic start-up when battery low: the <b>APM303</b> is in <b>AUTO</b> mode, the generating set has been started up, as low battery voltage has been detected.
	Automatic shutdown after battery recharge: the <b>APM303</b> is in <b>AUTO</b> mode, the generating set has been stopped, as the delay for battery charging has elapsed.
	Modbus order received: a remote order has been received by the <b>APM303</b> (see Modbus manual also).

### 7.2 Anomalies

An anomaly can be an alarm or a fault.

anomaly	if generating set stopped	if generating set operating	status of <b>ALARM!</b> LED
<b>alarm</b>	generating set start-up possible	no generating set shutdown	<b>ALARM!</b> flashing
<b>fault</b>	generating set start-up not possible	immediate shutdown of generating set	<b>ALARM!</b> flashing

#### 7.2.1 Appearance of an alarm

- If the **ALARM!** LED is flashing.
- the exclamation mark symbol opposite flashes in the top right of the screen "1-Main" (figure 13).

The alarm is recorded in the stack of events and anomalies (see section 'Events and anomalies, screen 6').



Figure 13 - appearance of an alarm

#### 7.2.2 Clearing an alarm

- An alarm which is active (or present) cannot be cleared manually. it automatically becomes inactive when the problem which caused the alarm disappears (e.g.: the generating set overload disappears when there is a reduction in the load).
- When the alarm switches to inactive, the **ALARM!** LED goes off, the exclamation mark symbol disappears from the "1-main" screen, the alarm remains visible on the "6-events and anomalies" screen.

description	status	screen shows "6-faults and events"	status of <b>ALARM!</b> LED
alarm	<b>active</b>		<b>flashing</b>
alarm	<b>inactive</b>		<b>off</b>

### 7.2.3 Alarm chart

The table below lists all the alarms which can be recorded in the stack.

symbol	description
	<b>Low battery voltage or charging alternator malfunction:</b> appears when the battery voltage is below the set threshold after the fixed delay of 3 minutes. This symbol also appears if there is a charging alternator malfunction.
	<b>Flat battery:</b> if the <b>APM303</b> cannot start up the generating set (because the battery voltage is too low), this alarm will be activated, but the starting sequence is not blocked.
	<b>Low fuel level:</b> appears when the daily service tank reaches the low fuel level threshold <b>E11</b> and if parameter <b>E15</b> is set to 1 (alarm).
	<b>Generating set overload:</b> appears when the output in kW supplied by the alternator exceeds the set threshold <b>G07</b> , after the delay <b>G08</b> .
	<b>Rotation of alternator phases:</b> may appear on start-up, if an incorrect rotation of phases is detected as a result of the installation being incorrectly wired.
	<b>Alarm input no. x (x=1, 2 or 3):</b> appears when the input configured in "alarm x" is active (x takes values 1, 2 or 3).
	<b>Generating set maintenance due (non-contractual):</b> appears when the value of parameter <b>E07</b> has been reached, meaning that maintenance is due (*).

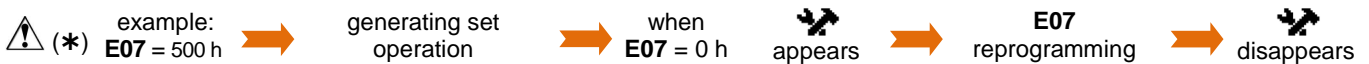

### 7.2.4 Appearance of a fault

- If the **ALARM!** LED is flashing.
- the exclamation mark symbol opposite flashes in the top right of the screen "**1-Main**" (figure 14).

The fault is recorded in the stack of events and anomalies (see section 'Events and anomalies, screen 6').



Figure 14 - appearance of a fault

### 7.2.5 Clearing a fault

- A fault which is active (or present) can be cleared manually by pressing the **STOP** button (). Clearing a fault means that the user acknowledges the fault. It does not change the fact that the fault remains active and it is not possible to restart the generating set.
- When the fault is cleared, the **ALARM!** LED lights up fixed, the exclamation mark symbol no longer flashes but remains on the "**1-main**" screen, the fault remains visible on the "**6-events and anomalies**" screen.
- To make a fault inactive, you must find the root cause behind the appearance of the fault (e.g.: emergency stop triggered).
- When the fault becomes inactive, the **ALARM!** LED goes off, the exclamation mark symbol disappears from the "**1-main**" screen, the fault remains visible on the "**6-events and anomalies**" screen.

description	status	screen shows "6-faults and events"	status of <b>ALARM!</b> LED
fault	<b>active, not cleared</b>		<b>flashing</b>
fault	<b>inactive not cleared</b>		<b>flashing</b>
fault	<b>active cleared</b>		<b>lit fixed</b>
fault	<b>inactive cleared</b>		<b>off</b>

### 7.2.6 Fault chart

The table below lists all the faults which can be recorded in the stack.

symbol	description
	<b>Emergency stop:</b> appears when the user presses the emergency stop button, located on the central console on the enclosure, or at the entrance to the electrical room.
	<b>Low fuel level:</b> appears when the daily service tank reaches the low fuel level threshold <b>E11</b> and if parameter <b>E15</b> is set to 2 (fault).
	<b>Low oil pressure:</b> appears if the engine oil pressure is too low (less than or equal to 1 Bar) or if the binary input is active.
	<b>High coolant temperature:</b> appears if the engine coolant temperature is too high (above the activation threshold).
	<b>Overspeed:</b> appears if the generating sets exceeds 120% of nominal speed. The safety feature is set at 150% for 5 seconds on generating set start-up.
	<b>Under speed:</b> appears when, after a full start-up, the generating set stops automatically after operating correctly for at least 5 seconds.
	<b>Max. alternator voltage (59):</b> appears when the alternator voltage reaches or exceeds the set threshold (parameter <b>G01</b> ), after a delay of 3 seconds.
	<b>Min. alternator voltage (27):</b> appears when the alternator voltage reaches or dips below the set threshold (parameter <b>G02</b> ), after a delay of 3 seconds.
	<b>Max. alternator frequency (81H):</b> appears if the alternator's frequency reaches or exceeds the set threshold (parameter <b>G03</b> ), after a delay of 3 seconds.
	<b>Min. alternator frequency (81):</b> appears when the alternator frequency reaches or dips below the set threshold (parameter <b>G04</b> ), after a delay of 3 seconds.
	<b>Alternator short-circuit (50/51):</b> appears if the current consumed by the alternator reaches or exceeds the set threshold (parameter <b>G05</b> ), after the delay <b>G06</b> which can be adjusted.
	<b>Generating set start-up failure:</b> appears if the generating set fails to start up after a full starting sequence.
	<b>Generating set shutdown failure:</b> appears after a shutdown request in <b>AUTO</b> or <b>MANUAL</b> mode, if the speed exceeds 2 rpm, or if the voltage exceeds 10V, or if the oil pressure remains higher than 3Bar, or if the generating set is started up when no start demand has been given by the <b>APM303</b> . The safety feature is taken into account after fixed delay of 60 seconds.
	<b>Fault input no. x (x=1, 2 or 3):</b> appears when the input configured in "fault x" is active (x takes values 1, 2 or 3).
	<b>Circuit breaker position inconsistent:</b> appears if there is an inconsistency between the motorised command from the circuit breaker and the position of the circuit breaker (open, closed), after a delay of 5 seconds.

Note: the figures between brackets (which may be accompanied by a letter) are the ANSI codes for the safety features (ANSI = American National Standards Institute).

### 7.2.7 Other anomaly displays

An anomaly referring to a mechanical or electrical value can be viewed on screens **1, 2, 3** or **4**.

E.g.: "low battery voltage" alarm displayed on screen **4**.

Parameter **E06** (minimum battery voltage) is set at 20Volts.

The battery voltage value appears with inverted backlighting and is equal to 19.5Volts.



Figure 15 - an alarm displayed on the measurements screen















## 8 Settings

### 8.1 Home screen

The home screen is only displayed when the **APM303** is powered up. This screen can only be customised using the configuration software (see user/operator level manual - configuration software).

### 8.2 Accessing settings (Main menu)

The settings can only be accessed if the **APM303** is in **Manual** mode. Access to the settings varies according to whether or not the home screen is displayed.

	without home screen (standard application)	with home screen (customised application)
①	press and hold 	press and hold 
②	press and hold  + press once 	press and hold  + press once 
③	press and hold  + press once 	press and hold  + press once 
④		press and hold  + press once 

The 3 "**ALARM!**", "**AUTO**" and "**RUN**" LEDs light up fixed, the **APM303** automatically switches to settings mode, and the "**main menu**" below is displayed (figure 16).

The 7 different screens can be accessed using 7 icons. The first icon flashes by default. To select an icon:













- Press one of the 2 buttons  or , until the required icon flashes.
- Press the  button to enter the selected screen.
- Press the  button to exit the selected screen and return to the main menu.

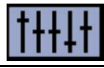

Figure 16 - main menu

- Press the  button again to exit the main menu. The "**Miscellaneous information**" screen is displayed and the 3 LEDs flash, the **APM303** automatically resets. After 6 seconds, it automatically returns to the "**1-main**" screen.
- It is possible to bypass this 6 second delay by pressing the  again, when the "**Miscellaneous information**" screen is displayed. In this case, the "**1-main**" screen is automatically displayed.

### 8.3 Available screens

icon	screen description	contents and details	how to modify a parameter
	Basic settings	section " <i>Basic settings</i> " screen'	section ' <i>Setting principle in other screens</i> '
	Motor protection and parameters	section " <i>Engine safety features and parameters</i> " screen'	section ' <i>Setting principle in other screens</i> '
	Alternator protection	section " <i>Alternator safety features</i> " screen'	section ' <i>Setting principle in other screens</i> '
	Modbus communication parameters	section " <i>Modbus communication</i> " screen'	section ' <i>Setting principle in other screens</i> '
	Output settings	section " <i>Output settings</i> " screen'	sections ' <i>Selecting an output</i> ' to ' <i>Confirming the output</i> '
	Input settings	section " <i>Input settings</i> " screen'	sections ' <i>Selecting an input</i> ' to ' <i>Confirming the input</i> '
	Miscellaneous information	section " <i>Miscellaneous information</i> " screen'	

## 8.4 Basic settings screen

The parameters available in the "Basic settings" screen are listed below.

No.	description	setting	by default
B01	nominal voltage phase/neutral (*)	from 80V to 480V (in increments of 1V)	230
B02	nominal voltage phase/phase (*)	from 80V to 600V (in increments of 1V)	400
B03	nominal frequency	1 = 50Hz, 2 = 60Hz	1
B04	connection type	1=1Ph+N, 2=2Ph+N, 3=3Ph, 4=3Ph+N	4
B05	unit format	1=Bar and °C, 2=PSI and °F	1
B07	zero consumption mode	from 0 to 360min (in increments of 1min)	0
B09	nominal current	from 1A to 5000A (in increments of 1A)	50
B10	primary CT	from 1A to 5000A	50
B11	nominal speed	from 100 to 4000rpm (in increments of 1rpm)	1500
B12	nominal power	from 1 to 3000kW (in increments of 1kW)	100
B13	automatic screen scrolling	1 = active, 2 = inactive	1
B14	automatic voltage and frequency detection	1= inactive, 2=active	1
B15	fuel solenoid valve type	1=diesel, 2=gas	1
B16	priority mode selection	1=MANUAL, 2=AUTO	1

(\*) B01 only displays if B04 is set to 1      B02 only displays if B04 is set to 2, 3 or 4

## 8.5 Engine safety features and parameters screen

The parameters available in the "Engine safety features and parameters" screen are listed below.

No.	description	setting	by default
E01	preheating delay	from 0 to 600s (in increments of 1s)	10
E02	starter attempt delay	from 0 to 60s (in increments of 1s)	5
E03	cooling delay	from 0 to 3600s (in increments of 1s)	180
E04	oil pressure fault threshold	from 0 to 10Bar	1 (3s)
E05	coolant temperature fault threshold	0 to 150°C	90 (5s)
E06	min. battery voltage threshold	from 8 to 40V	11.5 (3min)
E07	maintenance alarm threshold	from 0 to 10000h	9999
E08	starter cut off due to oil pressure	1= inactive, 2=active	1
E10	stabilisation delay	from 1 to 300s	5
E11	low fuel level anomaly threshold	from 0 to 80%	20 (10s)
E12	preheating maintenance delay (*)	from 0 to 3600s	30
E13	automatic start when battery voltage at minimum	1 = active, 2 = inactive	1
E14	min. battery voltage recharge delay	1 to 240min	60
E15	low fuel level anomaly	1=alarm; 2=fault	1

(\*) when the generating set is started up (used for cold countries)

Note: certain values are associated with a fixed delay, given in brackets.

## 8.6 Alternator safety features screen

The parameters available in the "Alternator safety features" screen are listed below.

No.	description	setting	by default
G01	max. voltage fault	from G02 to 200% (increments of 1%) (*)	110 (3s)
G02	min. voltage fault	from 0 to G01% (increments of 1%) (*)	70 (3s)
G03	maximum frequency fault	from to G04 to 130% (increments of 1%) (**)	110 (3s)
G04	min. frequency fault	from 0 to G03% (increments of 1%) (**)	85 (3s)
G05	short circuit fault	from 100 to 500% (increments of 1%) (***)	150 (G06)
G06	short circuit delay	from 0 to 10s (in increments of 1s)	0
G07	overload alarm	from 70 to 130% (increments of 1%) (***)	110 (G08)
G08	overload delay	from 0 to 300s (increments of 1s)	10

Note: certain values are associated with a fixed or variable delay, given in brackets.

(\*) in percentage of nominal U (parameter B01 or B02)

(\*\*) in percentage of nominal F (parameter B03)

(\*\*\*) in percentage of nominal I (parameter B09)

(\*\*\*\*) in percentage of nominal P (parameter B12)

## 8.7 Modbus communication screen

The parameters available in the "Modbus communication" screen are listed below.

No.	description	setting	by default
M01	speed (in Bauds/s)	1=9600, 2=19200, 3=38400, 4=57600	1
M02	stop bit	1=1 stop bit, 2=2 stop bits	1
M03	parity	1=no, 2=even, 3=odd	1
M04	address	from 1 to 247	5

For more information on Modbus communication, see the Modbus operator manual.

## 8.8 Output settings screen



The configurable outputs are marked T07 to T09. Each output can be assigned an "output code". Each "output code" performs a specific function. The table below lists these functions.

output code	function	output type	wiring to ...
O00	not used	-	-
O03	solenoid stop control	binary	
O04	general fault & alarm report	binary	terminal T09
O05	GCB opening and closing control	binary	
O07	"ready to generate" report	binary	terminal T08
O08	air preheating control	binary	terminal T07
O10	starter command	binary	
O11	glow plug preheating control	binary	
O12	low fuel level alarm report	binary	
O13	shut-off control valve	binary	
O14	general alarm report	binary	
O15	general fault report	binary	

GCB = Generator Circuit Breaker



⚠  
the standard configuration  
"output codes" are greyed  
out.

### 8.8.1 Selecting an output

- In the row displaying T07 T08 T09, the T07 output flashes.
- **Select** the output to be programmed, by pressing the  button.
- **Confirm** the selected output, by pressing the  button.





### 8.8.2 Selecting the "output code"

- In the column displaying O04 O05 O07 O08, the "output code" programmed on the output selected previously (e.g. O08) flashes.
- **Select** the desired "output code", by pressing the  or  button (see section "Output settings" screen for possible output codes).
- **Confirm** the "output code" selected, by pressing the  button.



### 8.8.3 Selecting the output action type



- **Select** the output action type by pressing the  or  button.



- **Confirm** the output action type, by pressing the  button.



### 8.8.4 Confirming the output

- **Confirm** the entire function programmed (output number, function, action type), by pressing the  button again.
- To make any changes to the programming (**before confirming**), press the  button then the  button to cancel the programming. Return to section 'Selecting an output' to select a new output.





### 8.9 Input settings screen

The configurable inputs are marked T10 to T15. Each input can be assigned an "input code". Each "input code" performs a specific function. The table below lists these functions.

input code	function	input type	wiring to ...
I00	not used	-	-
I02	remote start order	binary	terminal T10
I04	locking the APM303	binary	
I07	return to generator breaker position	binary	
I10	external alarm no. 1	binary	
I11	external alarm no. 2	binary	
I12	external alarm no. 3	binary	
I13	external fault no. 1	binary	terminal T11
I14	external fault no. 2	binary	
I15	external fault no. 3	binary	
I20	low fuel level	binary	
I21	fuel level	analog	terminal T13
I22	low oil pressure	binary	
I23	oil pressure	analog	terminal T15
I24	high coolant temperature	binary	terminal T12
I25	coolant temperature	analog	terminal T14



  
the standard configuration "input codes" are greyed out.

#### 8.9.1 Selecting an input

- In the row displaying T10 T11 T12 T13 T14, the T10 input flashes.
- **Select** the input to be programmed by pressing on the  or  button.
- **Confirm** the selected input, by pressing the  button.



#### 8.9.2 Selecting the "input code"

- In the column displaying I00 I02 I04 I07, the "input code" programmed on the input selected previously (e.g. I02) flashes.
- **Select** the desired "input code", by pressing the  or  button (see section "Input settings" screen for possible input codes).
- **Confirm** the "input code" selected, by pressing the  button.





#### 8.9.3 Selecting the input action type

- **Select** the input action type by pressing the  or  button.



- **Confirm** the input action type, by pressing the  button.

### 8.9.4 Confirming the input

- **Confirm** the entire function programmed (input number, function, action type), by pressing the  button again.
- To make any changes to the programming (before confirming), press the  button then the  button to cancel the programming. Return to section 'Selecting an input' to select a new input.







### 8.10 Miscellaneous information screen

This screen displays general information about the generating set and the **APM303** module. This screen corresponds to screen **0** described in section 'INIT, screen 0'.

### 8.11 Setting principle in other screens

This section explains how to access and modify a parameter in the screens opposite.

The explanations below concern the "basic settings" screen, but they are also valid for the other 3 screens.

icon	screen description
	Basic settings
	Motor protection and parameters
	Alternator protection
	Modbus communication parameters

A cursor is position on the first parameter (**B01** or **B02** depending on the setting of **B04**). A maximum of 6 parameters appear on screen.

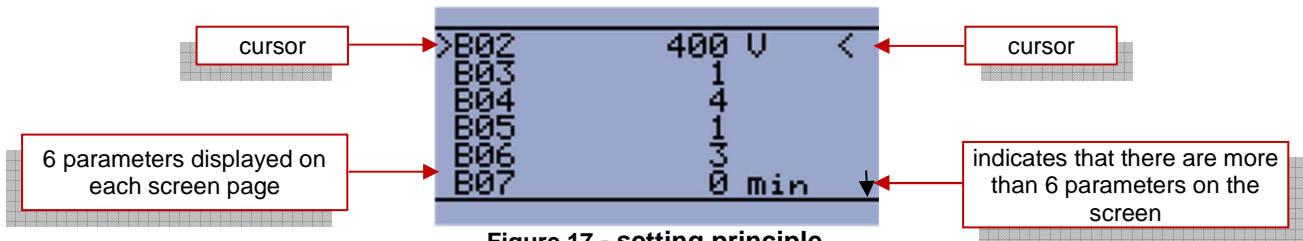











Figure 17 - setting principle

- **to select** a parameter: press the  or  button (the cursor moves up or down) (pressing  at the top of the screen does not work) (pressing  at the bottom of the screen does not work)
- **to access** a parameter: press the  button, the parameter value appears in a dark box (inverted backlighting) e.g.: with **B02** selected, **400** is displayed
- **to modify** a parameter: press the  or  buttons to change the parameter value; press as many times as necessary, or press and hold the button until the desired setting is displayed e.g.: with **B02** (400V) selected, press 10 times to obtain 410V
- **to confirm** the change: press the  button to confirm the parameter change
- **to exit** the screen: press the  button, to return to the "main menu" screen

## 9 Connections

### 9.1 Rear panel connections

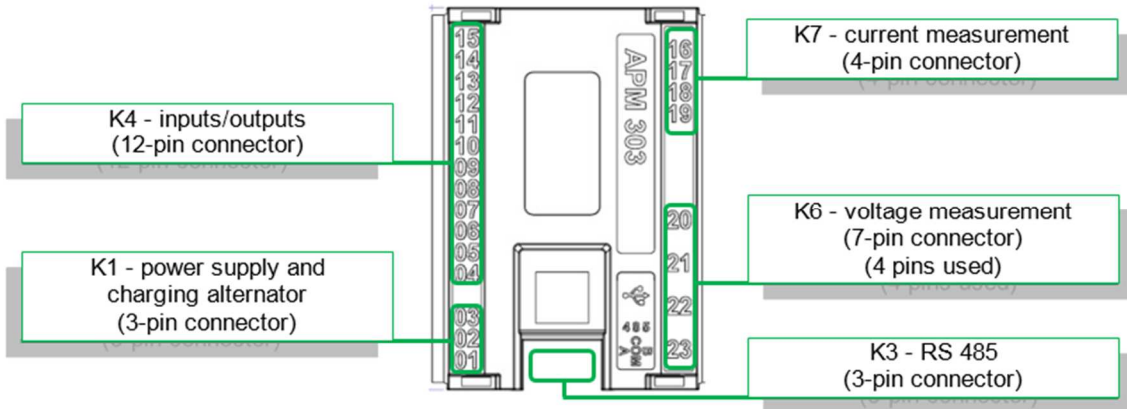

Figure 18 - rear panel and connections

### 9.2 K6 connector/voltage measurement

Depending on the type of installation, the voltage measurement connection on the 7-pin connector will differ.

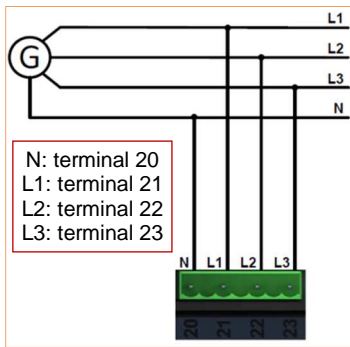

Figure 19 - three phase 3P+N (4 wires)

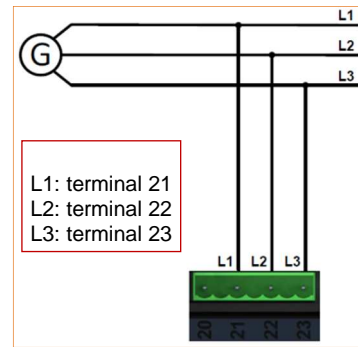

Figure 20 - three phase 3P (3 wires)

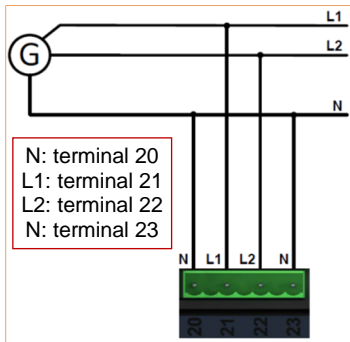

Figure 21 - two phase 2P+N (3 wires)

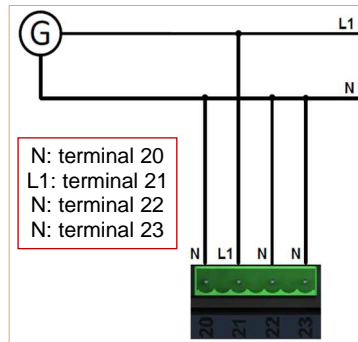

Figure 22 - single phase 1P+N (2 wires)

## 10 Technical specifications

### **Control unit**

. dimensions	118 x 108 x 40 (length x height x depth)
. protection index	IP54 on front panel, IP20 on rear, connectors side
. weight without packaging	200g
. cut-out for assembly	94 x 94 minimum (+/-1 mm)
. tightening torque for assembly	from 15 to 20cNm

### **Environment**

. operating temperature	-20°C to +70°C
. storage temperature	-30°C to +80°C
. humidity	95% at 45°C, 70% at 50°C, 50% at 60°C

### **Power supply**

. <b>T01</b> terminals (0 V battery) and <b>T03</b> (+ battery) (on 3-pin connector)	. nominal voltage 12Vdc or 24Vdc . voltage range from 8 to 36Vdc
---	---

### **Binary inputs**

. 6 binary inputs, terminals <b>T10, T11, T12, T13, T14</b> and <b>T15</b> (on 12-pin connector)	. not isolated . connected to <b>0Vdc</b>
---	--

### **Emergency stop input**

. 1 binary input, terminal <b>T04</b> (on 12-pin connector)	. not isolated . connected to <b>+ battery</b>
--	---

### **Binary outputs**

. 5 binary outputs, terminals <b>T05, T06, T07, T08, T09</b> (on 12-pin connector)	. not isolated . operating range from 8 to 36Vdc . flyback diode required for inductive load . safety feature protecting against: short-circuit, overload, overvoltage peaks . not protected against polarity inversion
---	---

### **Analog inputs**

3 analog inputs, terminals <b>T13, T14, T15</b> (on 12-pin connector)	. not isolated . measurement range: from 0 to 2500Ω
--	--

### **Voltage measurement**

. . 1 input, terminals <b>T20, T21, T22, T23</b> (on 7-pin connector) with 1 of the 2 pins not used (see section 10 for possible connections)	. true RMS value . voltage range: from 80 to 480Vac between phases from 50 to 277Vac between phase and neutral . not isolated
--	--

### **Frequency measurement**

. 1 input, terminal <b>T21</b> (phase 1) (on 7-pin connector)	. measurement on the fundamental
--	----------------------------------

### **Current measurement**

. . 1 input, terminals <b>T16, T17, T18, T19</b> (on 4-pin connector)	. true RMS value . measurement range: from 100mA to 6A (secondary CT) . not isolated
--	--

### **Charging alternator excitation**

. 1 binary input/output, terminal <b>T02</b> (on 3-pin connector)	. excitation current: 100mA
--	-----------------------------

### **Communication**

. USB (on B type connector)	. device type . on the module
--------------------------------	----------------------------------

### **RS485 interface**

1 input/output, 3 terminals ( <b>A, COM, B</b> ) (on 3-pin connector)	RS485 type . on the module
--	-------------------------------

## 11 Packaging, storage and handling of the modules

### 11.1 Packaging

- Each module is supplied separately in a cardboard box.
- Each cardboard box has a glued identification label, which corresponds to the module reference.
- The modules must remain in their original packaging until they are integrated, i.e. "mechanically" and "electrically" installed, in the control/command equipment.

### 11.2 Storage

The storage conditions described below must be strictly adhered to, otherwise there is a risk that the product warranty will be completely voided by SDMO and/or by the manufacturer of the products.

- Store in a location free from dust.
- Temperature: -20°C to +70°C.
- Relative humidity: from 5% to 95% with no condensation.
- The modules may be stacked on top of each other, provided the following conditions are observed:
  - stored flat ⇒ **recommended**
  - stored at an angle ⇒ **not recommended**

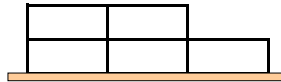

Figure 23 - stored flat

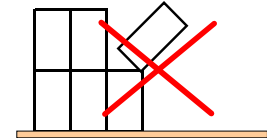

Figure 24 - stored at an angle

### 11.3 Handling

#### 11.3.1 Module packed in its box

- No particular conditions need to be observed; handle the products with care, avoiding any impacts.
- Bring the modules as close as possible to the workstation, before removing them from their original packaging.

#### 11.3.2 Module not packed in its box

All electronic equipment is sensitive in varying degrees to static electricity. To protect the components against the effects of static electricity, it is necessary to follow the following special precautions to minimise or prevent any electrostatic discharges.

- Insofar as possible, avoid wearing synthetic clothing and wear cotton clothing whenever possible, as this does not generate static electricity.
- Before removing the module from its packaging, touch a metal earth with your hand to discharge the body of any static electricity, which could cause damage to the electronic components.
- When installing the module in its surroundings, or if you move outside the working area, it will be necessary to touch a metal earth again when re-entering the working area, as any movement along the ground can charge the body with static electricity.
- If a module needs replacing (for instance, for repair), place the replaced module in its original packaging or, if not possible, in an antistatic plastic bag of a suitable size for the module.

 It is formally prohibited to lift up the metal enclosure at the rear of the module; failure to observe this risks voiding the product warranty provided by SDMO and/or the product manufacturer completely.



Figure 25 - antistatic plastic bag

