

## LSA 46.3

### Low Voltage Alternator - 4 pole Installation and maintenance

**LEROY-SOMER™**

***Nidec***  
All for dreams

# LSA 46.3

## Low Voltage Alternator - 4 pole

**This manual concerns the alternator which you have just purchased. We wish to draw your attention to the contents of this maintenance manual.**

### SAFETY MEASURES

Before using your machine for the first time, it is important to read the whole of this installation and maintenance manual.

All necessary operations and interventions on this machine must be performed by a qualified technician.

Our technical support service will be pleased to provide any additional information you may require.

The various operations described in this manual are accompanied by recommendations or symbols to alert the user to potential risks of accidents. It is vital that you understand and take notice of the following warning symbols.

#### WARNING

**Warning symbol for an operation capable of damaging or destroying the machine or surrounding equipment.**



**Warning symbol for general danger to personnel.**



**Warning symbol for electrical danger to personnel.**

### SAFETY INSTRUCTIONS

We wish to draw your attention to the following 2 safety measures which must be complied with:

**a) During operation, do not allow anyone to stand in front of the air outlet guards, in case anything is ejected from them.**

**b) Do not allow children younger than 14 to go near the air outlet guards.**

A set of self-adhesive stickers depicting the various warning symbols is included with this maintenance manual. They should be positioned as shown in the drawing below once the machine has been fully installed.

### WARNING

**The alternators must not be put into service until the machines in which they are to be incorporated have been declared compliant with Directives EC and plus any other directives that may be applicable.**

**This manual is to be given to the end user.**

**The range of electric alternators and their derivatives, manufactured by us or on our behalf, comply with the technical requirements of the customs Union directives (EAC).**

© - We reserve the right to modify the characteristics of this product at any time in order to incorporate the latest technological developments. The information contained in this document may therefore be changed without notice.

This document may not be reproduced in any form without prior authorisation. All brands and models have been registered and patents applied for.

# LSA 46.3

## Low Voltage Alternator - 4 pole

### CONTENTS

<b>1 - RECEIPT .....</b>	<b>4</b>
1.1 - Standards and safety measures .....	4
1.2 - Inspection .....	4
1.3 - Identification .....	4
1.4 - Storage .....	4
1.5 - Applications .....	4
1.6 - Usage restrictions .....	4
<b>2 - TECHNICAL CHARACTERISTICS .....</b>	<b>5</b>
2.1 - Electrical characteristics .....	5
2.2 - Mechanical characteristics .....	5
<b>3 - INSTALLATION .....</b>	<b>6</b>
3.1 - Assembly .....	6
3.2 - Checks prior to first use .....	6
3.3 - Terminal connection diagrams .....	7
3.4 - Commissioning .....	10
3.5 - Setting up .....	10
<b>4 - SERVICING - MAINTENANCE .....</b>	<b>11</b>
4.1 - Safety measures .....	11
4.2 - Routine maintenance .....	11
4.3 - Bearings .....	12
4.4 - Mechanical defects .....	12
4.5 - Electrical faults .....	13
4.6 - Dismantling, reassembly .....	15
4.7 - Installation & maintenance of the PMG .....	17
4.8 - Table of characteristics .....	17-18
<b>5 - SPARE PARTS .....</b>	<b>19</b>
5.1 - First maintenance parts .....	19
5.2 - Technical support service .....	19
5.3 - Accessories .....	19
5.4 - Exploded views, parts list and tightening torque .....	20

**Disposal and recycling instructions**

**Declaration of EC compliance and incorporation**

# LSA 46.3

## Low Voltage Alternator - 4 pole

### 1 - RECEIPT

#### 1.1 - Standards and safety measures

Our alternators comply with most international standards.

See the EC Declaration of Incorporation on the last page.

#### 1.2 - Inspection

On receipt of your alternator, check that it has not suffered any damage in transit. If there are obvious signs of knocks, contact the transporter (you may be able to claim on their insurance) and after a visual check, turn the machine by hand to detect any malfunction.

#### 1.3 - Identification

The alternator is identified by means of a nameplate fixed on the machine (see drawing).

Make sure that the nameplate on the machine conforms to your order.

So that you can identify your alternator quickly and accurately, we suggest you fill in its specifications on the nameplate below.

#### 1.4 - Storage

Prior to commissioning, machines should be stored :

- away from humidity (< 90%); after a long period of storage, check the machine insulation. To prevent the bearings from becoming marked, do not store in an environment with significant vibration.

#### 1.5 - Application

These alternators are mainly designed to produce electricity in the context of applications involving the use of generators.

#### 1.6 - Usage restrictions

Use of the machine is restricted to operating conditions (environment, speed, voltage, power, etc) compatible with the characteristics indicated on the nameplate.

## Leroy-Somer

LSA		IP	
N°:		Date :	
r.p.m.	Hz	Weight : kg	
P.F. :	Th.class.	Altitude : m	
A.V.R.		Excit.	
Excit. values	full load : V / A		
	at no load : A		
D.E. bearing			
N.D.E. bearing			



IEC 60034 - 1 & 5. / ISO 8528 - 3. / NEMA MG1 - 32 & 33.

RATINGS			
Voltage			V
Phase			
Conn.			
Contin.			kVA
B.R.			kW
40°C.			A
Std by			kVA
P.R.			kW
27°C.			A
Made in .....			

Moteurs Leroy-Somer - Boulevard Marcellin Leroy,  
CS 10015 - 16915 Angoulême Cedex 9 - France

LSA.000-1-006 e

# LSA 46.3

## Low Voltage Alternator - 4 pole

### 2 - TECHNICAL CHARACTERISTICS

#### 2.1 - Electrical characteristics

This alternator is a machine without sliprings or revolving armature brushes, wound as "2/3 pitch", 6 or 12-wire, with class H insulation and a field excitation system available in either SHUNT, AREP or PMG version (see diagrams and AVR manuals).

#### • Electrical options

- Stator temperature detection sensors
  - Bearing sensors (PTC, PT100, etc)
  - Space heater
- In order to conform to standard EN 61000-6-3, EN 61000-6-2, EN 55011, the R 791 interference suppression kit is needed.

#### • SHUNT three-phase 12-wire

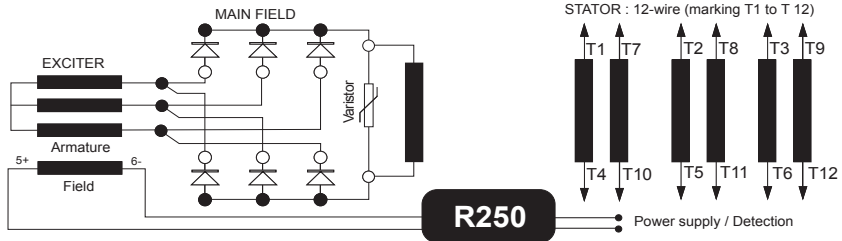

#### • AREP three-phase 6 or 12-wire

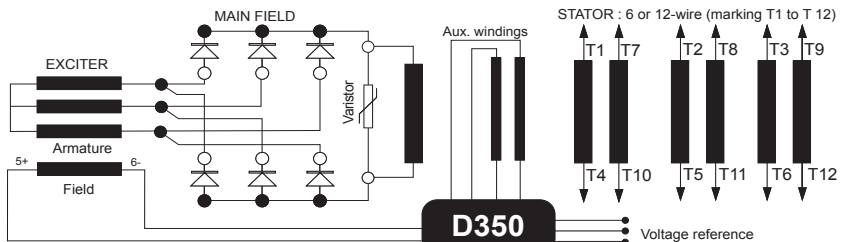

#### • PMG three-phase 6 or 12-wire

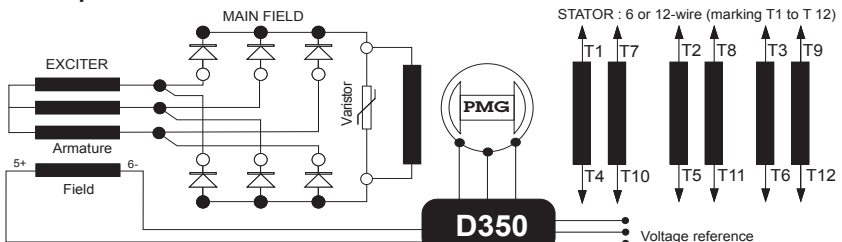

#### 2.2 - Mechanical characteristics

- Steel frame
- Cast iron end shields
- Protected ball bearings, greased for life
- Mounting arrangements: foot and flange mounted, single-bearing with SAE coupling disc, double-bearing with SAE flange and standard cylindrical shaft extension
- Drip-proof machine, self-cooled
- Degree of protection: IP 23

#### • Mechanical options

- Air inlet filter
- Regreasable ball bearings
- IP 44 protection

# LSA 46.3

## Low Voltage Alternator - 4 pole

### 3 - INSTALLATION

Personnel undertaking the various operations indicated in this section must wear personal protective equipment appropriate for mechanical and electrical hazards.

#### 3.1 - Assembly



All mechanical handling operations must be undertaken using suitable equipment and the machine must be horizontal. Check how much the machine weighs before choosing the lifting tool. During this operation, do not allow anyone to stand under the load.

##### • Handling

The generously-sized lifting eyes are for handling the alternator only. They must not be used to lift the genset. The choice of lifting hooks or handles should be determined by the shape of the lifting eyes. Choose a lifting system which respects the integrity and the environment of the machine.

During this operation, do not allow anyone to stand under the load.

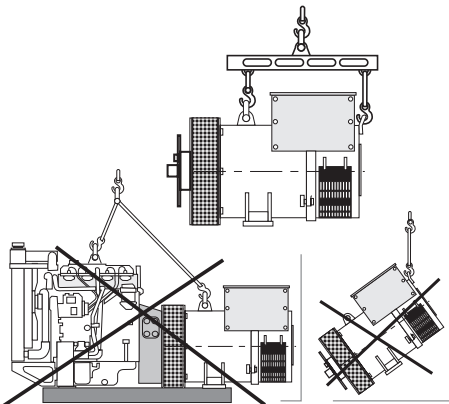

##### • Single-bearing coupling

Before coupling, check the compatibility between the alternator and the engine by performing:

- undertaking a torsional analysis of the transmission (alternators data are available on request),
- checking the dimensions of the flywheel and its housing, the flange, coupling discs and offset.

#### WARNING

When coupling the alternator to the prime mover, do not use the fan to turn the alternator or rotor.

The holes of the coupling discs should be aligned with the flywheel holes by cranking the engine.

Make sure the machine is securely bedded in position during coupling.

Check that there is lateral play on the crankshaft.

##### • Double-bearing coupling

- Semi-flexible coupling

Careful alignment of the machines is recommended, checking that the lack of concentricity and parallelism of both parts of the coupling do not exceed 0.1 mm.

**This alternator has been balanced with a 1/2 key.**

##### • Location

The room where the alternator is placed must be ventilated to ensure that the ambient temperature cannot exceed the data on the nameplate.

#### 3.2 - Checks prior to first use

##### • Electrical checks



Under no circumstances should an alternator, new or otherwise, be operated if the insulation is less than 1 megohm for the stator and 100,000 ohms for the other windings.

## LSA 46.3

### Low Voltage Alternator - 4 pole

There are 2 possible methods for restoring the above minimum values.

a) Dry out the machine for 24 hours in a drying oven at a temperature of 110 °C (without the regulator).

b) Blow hot air into the air intake, having made sure that the machine is rotating with the exciter field disconnected.

#### **Note : Prolonged standstill**

In order to avoid these problems, we recommend the use of space heaters, as well as turning over the machine from time to time. Space heaters are only really effective if they are working continuously while the machine is stopped.

### **WARNING**

**Ensure that the alternator has the degree of protection matching the defined environmental conditions.**

#### **• Mechanical checks**

Before starting the machine for the first time, check that:

- all fixing bolts are tight,
- the length of bolt and the tightening torque are correct,
- the cooling air is drawn in freely,
- the protective grills and housing are correctly in place,
- the standard direction of rotation is clockwise as seen from the drive end (phase rotation in order 1 - 2 - 3).

For anti-clockwise rotation, swap 2 and 3.

- the winding connection corresponds to the site operating voltage (see section 3.3).

#### **3.3 - Terminal connection diagrams**

To modify the connection, change the position of the stator cables on the terminals. The winding code is specified on the nameplate.











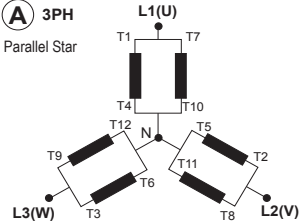
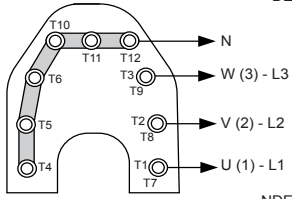

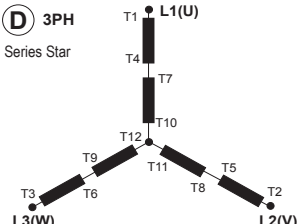
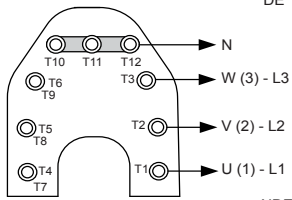
**Any intervention on the alternator terminals during reconnection or checks should be performed with the machine stopped. In no case should the internal connections in the terminal box be subjected to stresses due to cables connected by the user.**

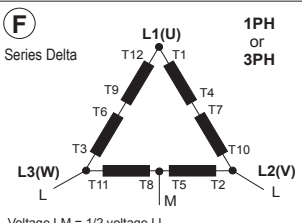
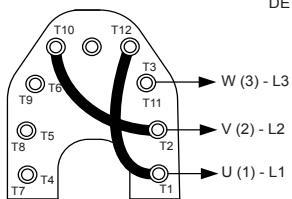
# LSA 46.3

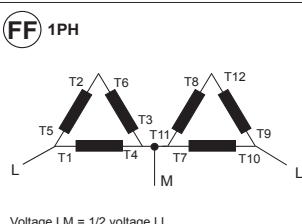
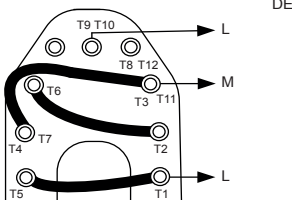
## Low Voltage Alternator - 4 pole

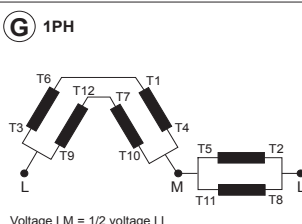
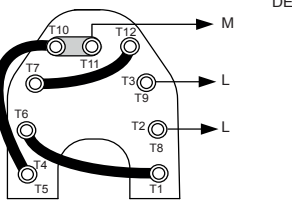
### • SHUNT, AREP or PMG three-phase 12-wire

Connection codes		Voltage / Detection			Factory connection 12 wires	
<b>A</b> 3PH Parallel Star 	Winding	50 Hz	60 Hz		DE	
	6	190 - 208	190 - 240			
	7	208 - 230	-			
	8	-	190 - 208			
<b>R250 :</b> 0 => T8 / 110V => T11 <b>D350 :</b> U => T1, V => T2, W => T3					NDE	
<b>D</b> 3PH Series Star 	Winding	50 Hz	60 Hz		DE	
	6	380 - 415	380 - 480			
	7	440 - 460	-			
	8	-	380 - 416			
<b>R250 :</b> 0 => T8 / 110V => T11 <b>D350 :</b> U => T1, V => T2, W => T3					NDE	
<b>F</b> 1PH or 3PH Series Delta 	Winding	50 Hz	60 Hz		DE	
	6	220 - 240	220 - 240			
	7	250 - 260	-			
	8	200	220 - 240			
<b>R250 :</b> 0 => T8 / 110V => T11 <b>D350 :</b> U => T1, V => T2, W => T3					NDE	
Voltage LM = 1/2 voltage LL						
<b>FF</b> 1PH 	Winding	50 Hz	60 Hz		DE	
	6	220 - 240	220 - 240			
	7	250 - 260	-			
	8	200	220 - 240			
<b>R250 :</b> 0 => T4 / 110V => T1 <b>D350 :</b> V => T1, W => T10					NDE	
Voltage LM = 1/2 voltage LL						
<b>G</b> 1PH 	Winding	50 Hz	60 Hz		DE	
	6	220 - 240	220 - 240			
	7	250 - 260	-			
	8	200	220 - 240			
<b>R250 :</b> 0 => T8 / 110V => T11 <b>D350 :</b> V => T2, W => T3					NDE	
Voltage LM = 1/2 voltage LL						

 In case of reconnection, ensure that AVR voltage detection is correct !  
 We can supply a set of flexible shunts and special connection links as an option for making these connections.



# LSA 46.3

## Low Voltage Alternator - 4 pole

### • AREP or PMG three-phase 6-wire

Connection codes		Voltage / Detection			Factory connection 6 wires	
<b>D</b> 3PH Star		Winding	50 Hz	60 Hz		
		6S	380 - 415	380 - 480		
		7S	440	-		
		8S	-	380 - 416		
		<b>D350 :</b> U => T1, V => T2, W => T3				
<b>F</b> 1PH or 3PH Delta		Winding	50 Hz	60 Hz		
		6S	220 - 240	220 - 240		
		7S	250 - 260	-		
		8S	200	220 - 240		
		<b>D350 :</b> U => T1, V => T2, W => T3				
Note: // alternator: CT -> L1 (In)						
In case of reconnection, ensure that AVR voltage detection is correct ! We can supply a set of flexible shunts and special connection links as an option for making these connections.						

### • Option connection diagram

R 791 T interference suppression kit (standard for CE marking)	Remote voltage potentiometer																																				
<p>Connections</p> <table border="1"> <thead> <tr> <th></th> <th>(A)</th> <th>(D)</th> <th>(F)</th> <th>(F/F)</th> <th>(G)</th> </tr> </thead> <tbody> <tr> <td>Black</td> <td>T1</td> <td>T1</td> <td>T1</td> <td>T1</td> <td>T2</td> </tr> <tr> <td>Black</td> <td>T2</td> <td>T2</td> <td>T2</td> <td>T2</td> <td>T3</td> </tr> <tr> <td>Black</td> <td>T3</td> <td>T3</td> <td>T3</td> <td>NC</td> <td>NC</td> </tr> <tr> <td>Blue</td> <td>N</td> <td>N</td> <td>N</td> <td></td> <td></td> </tr> <tr> <td>Green/Yellow</td> <td></td> <td></td> <td></td> <td></td> <td></td> </tr> </tbody> </table>		(A)	(D)	(F)	(F/F)	(G)	Black	T1	T1	T1	T1	T2	Black	T2	T2	T2	T2	T3	Black	T3	T3	T3	NC	NC	Blue	N	N	N			Green/Yellow						<p>Voltage adjustment via remote potentiometer</p>
	(A)	(D)	(F)	(F/F)	(G)																																
Black	T1	T1	T1	T1	T2																																
Black	T2	T2	T2	T2	T3																																
Black	T3	T3	T3	NC	NC																																
Blue	N	N	N																																		
Green/Yellow																																					

### Current transformer connection (optional)

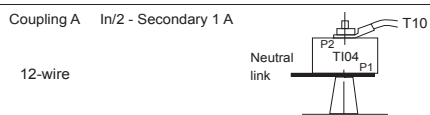
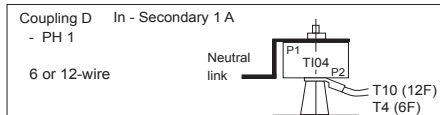

### Anti condensation heater

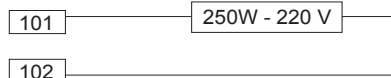

### Thermistor (PTC) temperature



# LSA 46.3

## Low Voltage Alternator - 4 pole

### • Connection checks



**Electrical installations must comply with the current legislation in force in the country of use.**

Check that:

- The residual circuit-breaker conforms to legislation on protection of personnel, in force in the country of use, and has been correctly installed on the alternator power output as close as possible to the alternator. (In this case, disconnect the wire of the interference suppression module linking the neutral).
- Any protection devices in place have not been tripped.
- If there is an external AVR, the connections between the alternator and the cabinet are made in accordance with the connection diagram.
- There is no short-circuit phase-phase or phase-neutral between the alternator output terminals and the generator set control cabinet (part of the circuit not protected by circuitbreakers or relays in the cabinet).
- The machine should be connected with the busbar separating the terminals as shown in the terminal connection diagram.



- The alternator earth terminal inside the terminal box is connected to the electrical earth circuit
  - The earth terminal is connected to the frame.
- The connections inside the terminal box must never be subjected to stress due to cables connected by the user.



Diameter	M6	M8	M10	M12
Torque	4 Nm	10 Nm	20 Nm	35 Nm
Tolerance	± 15%			

### 3.4 - Commissioning



**The machine can only be started up and used if the installation is in accordance with the regulations and instructions defined in this manual.**

The machine is tested and set up at the factory. When first used with no load, make sure that the drive speed is correct and stable (see the nameplate). With the regreasable bearing option, we recommend greasing the bearings at the time of commissioning (see section 4.3).

On application of the load, the machine should achieve its rated speed and voltage; however, in the event of abnormal operation, the machine setting can be altered (follow the adjustment procedure in section 3.5). If the machine still operates incorrectly, the cause of the malfunction must be located (see section 4.5).

### 3.5 - Setting up



**The various adjustments during tests must be made by a qualified engineer.**

**Ensure that the drive speed specified on the nameplate is reached before commencing adjustment.**

**After operational testing, replace all access panels or covers.**

**The AVR is used to make any adjustments to the machine.**

# LSA 46.3

## Low Voltage Alternator - 4 pole

### 4 - SERVICING - MAINTENANCE

#### 4.1 - Safety measures

Servicing or troubleshooting must be carried out strictly in accordance with instructions so as to avoid the risk of accidents and to maintain the machine in its original state.



All such operations performed on the alternator should be undertaken by personnel trained in the commissioning, servicing and maintenance of electrical and mechanical components, who must wear personal protective equipment appropriate for mechanical and electrical hazards.

Before any intervention on the machine, ensure that it cannot be started by a manual or automatic system and that you have understood the operating principles of the system.



**Warning :** During and after running, the alternator will reach temperatures hot enough to cause injury, such as burns.

#### 4.2 - Routine maintenance

##### • Checks after start-up

After approximately 20 hours of operation, check that all fixing bolts on the machine are still tight, plus the general state of the machine and the various electrical connections in the installation.

##### • Electrical servicing

Commercially-available volatile degreasing agents can be used.

### WARNING

Do not use: trichlorethylene, perchlorethylene, trichloroethane or any alkaline products.



These operations must be performed at a cleaning station, equipped with a vacuum system that collects and flushes out the products used.

The insulating components and the impregnation system are not at risk of damage from solvents. Avoid letting the cleaning product run into the slots.

Apply the product with a brush, sponging frequently to avoid accumulation in the housing. Dry the winding with a dry cloth. Let any traces evaporate before reassembling the machine.

##### • Mechanical servicing

### WARNING

Cleaning the machine using water or a highpressure washer is strictly prohibited. Any problems arising from such treatment are not covered by our warranty.

Degreasing: Use a brush and detergent (suitable for paintwork).

Dusting: Use an air gun.

If the machine is fitted with air inlet and outlet filters, the maintenance personnel should clean them routinely at regular intervals. In the case of dry dust, the filter can be cleaned using compressed air and/or replaced if it is clogged.

After cleaning the alternator, it is essential to check the winding insulation (see sections 3.2 and 4.5).

## LSA 46.3

### Low Voltage Alternator - 4 pole

#### 4.3 - Bearings

The bearings are permanently greased	Approximate life of the grease (depending on use) = 20,000 hours or 3 years.
As an option, the bearings are regreasable	Regreasing interval: 4000 hrs of operation DE bearing: Amount of grease: 33 gr NDE bearing: Amount of grease: 30 gr
Standard grease	LITHIUM - standard - NLGI 3
Grease used in the factory	ESSO - Unirex N3
 It is imperative to lubricate the alternator during operation and on first use. Before using another grease, check for compatibility with the original one.	

#### 4.4 - Mechanical defects

Fault		Action
Bearing	Excessive overheating of one or both bearings (bearing temperature 80°C above the ambient temperature)	<ul style="list-style-type: none"> <li>- If the bearing has turned blue or if the grease has turned black, change the bearing.</li> <li>- Bearing not fully locked (abnormal play in the bearing cage)</li> <li>- End shields incorrectly aligned</li> </ul>
Abnormal temperature	Excessive overheating of alternator frame (more than 40° C above the ambient temperature)	<ul style="list-style-type: none"> <li>- Air flow (inlet-outlet) partially clogged or hot air is being recycled from the alternator or engine</li> <li>- Alternator operating at too high a voltage (&gt;105% of Un on load)</li> <li>- Alternator overloaded</li> </ul>
Vibrations	Too much vibration	<ul style="list-style-type: none"> <li>- Misalignment (coupling)</li> <li>- Defective mounting or play in coupling</li> <li>- Rotor balancing fault (Engine - Alternator)</li> </ul>
	Excessive vibration and humming noise coming from the machine	<ul style="list-style-type: none"> <li>- Phase imbalance</li> <li>- Stator short-circuit</li> </ul>
Abnormal noise	Alternator damaged by a significant impact, followed by humming and vibration	<ul style="list-style-type: none"> <li>- System short-circuit</li> <li>- Misparalleling</li> </ul> <p>Possible consequences</p> <ul style="list-style-type: none"> <li>- Broken or damaged coupling</li> <li>- Broken or bent shaft end</li> <li>- Shifting and short-circuit of main field</li> <li>- Fan fractured or coming loose on shaft</li> <li>- Irreparable damage to rotating diodes/AVR, surge suppressor</li> </ul>

## LSA 46.3

### Low Voltage Alternator - 4 pole

#### 4.5 - Electrical faults

Fault	Action	Effect	Check/Cause
No voltage at no load on start-up	Connect a new battery of 4 to 12 volts to terminals E- and E+, respecting the polarity, for 2 to 3 seconds	The alternator builds up and its voltage is still correct when the battery is removed	- Lack of residual magnetism
		The alternator builds up but its voltage does not reach the rated value when the battery is removed	- Check the connection of the voltage reference to the AVR - Faulty diodes - Armature short-circuit
		The alternator builds up but its voltage disappears when the battery is removed	- Faulty AVR - Field windings open circuit (check winding) - Revolving field coil open circuit (check the resistance)
Voltage too low	Check the drive speed	Correct speed	Check the AVR connections (AVR may be faulty) - Field windings short-circuited - Rotating diodes burnt out - Revolving field coil short-circuited - Check the resistance
		Speed too low	Increase the drive speed (do not touch the AVR voltage pot. (P2) before running at the correct speed)
Voltage too high	Adjust AVR voltage potentiometer	Adjustment ineffective	Faulty AVR
Voltage oscillations	Adjust the AVR stability potentiometer	If no effect: try normal or fast stability modes (ST2)	- Check the speed: possibility of cyclic irregularity - Loose connections - Faulty AVR - Speed too low when on load (or AVR LAM set too high)
Voltage correct at no load and too low when on load	Run at no load and check the voltage between E+ and E- on the AVR	Voltage between E+ and E- (DC) SHUNT / AREP / PMG < 10V	- Check the speed (or AVR LAM set too high)
		Voltage between E+ and E- SHUNT / AREP / PMG > 15V	- Faulty rotating diodes - Short-circuit in the revolving field coil (check the resistance) - Faulty exciter armature (check the resistance)
Voltage disappears during operation	Check the AVR, the surge suppressor, the rotating diodes, and replace any defective components	The voltage does not return to the rated value	- Exciter winding open circuit - Faulty exciter armature - Faulty AVR - Revolving field coil open circuit or short-circuited

# LSA 46.3

## Low Voltage Alternator - 4 pole

### • Checking the winding

You can check the winding insulation by performing a high voltage test. In this case, you must disconnect all AVR wires.

### WARNING

Damage caused to the AVR in such conditions is not covered by our warranty.

### • Checking the diode bridge

A diode in good working order should allow the current to flow only in the anode-to-cathode direction.

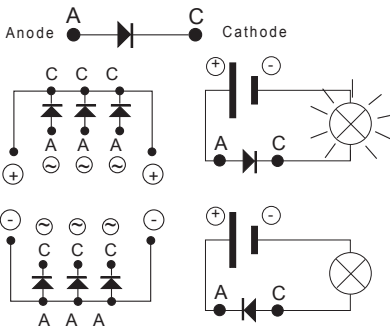

### • Checking the windings and rotating diodes using separate excitation



During this procedure, make sure that the alternator is disconnected from any external load and inspect the terminal box to check that the connections are fully tightened.

- 1) Stop the unit, disconnect and isolate the AVR wires.
- 2) There are two ways of creating an assembly with separate excitation.

**Assembly A:** Connect a 12 V battery in series with a rheostat of approximately 50 ohms - 300 W and a diode on both exciter field wires (5+) and (6-).

ASSEMBLY A

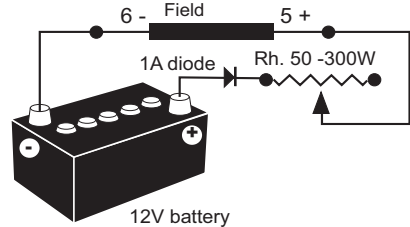

**Assembly B:** Connect a "Variac" variable power supply and a diode bridge on both exciter field wires (5+) and (6-).

Both these systems should have characteristics which are compatible with the field excitation power of the machine (see the nameplate).

3) Run the unit at its rated speed.

4) Gradually increase the exciter field current by adjusting the rheostat or the variac and measure the output voltages on L1 - L2 - L3, checking the excitation voltage and current at no load (see the machine nameplate or ask for the factory test report). When the output voltage is at its rated value and balanced within 1% for the rated excitation level, the machine is in good working order. The fault therefore comes from the AVR or its associated wiring (ie. sensing, auxiliary windings).

ASSEMBLY B

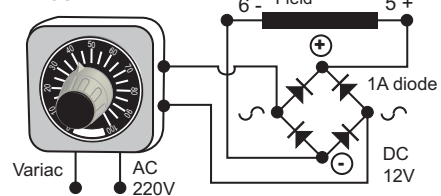

# LSA 46.3

## Low Voltage Alternator - 4 pole

### 4.6 - Dismantling, reassembly

#### WARNING

During the warranty period, this operation should only be carried out in an approved workshop or in our factory, otherwise the warranty may be invalidated.

Whilst being handled, the machine should remain horizontal (rotor not locked in position). Check how much the machine weighs before choosing the lifting method.

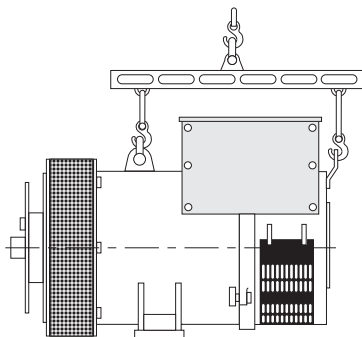

#### • Tools required

To fully dismantle the machine, we recommend using the tools listed below:

- 1 ratchet spanner + extension
- 1 torque wrench
- 1 set of flat spanners: 8 mm, 10 mm, 18 mm
- 1 socket set: 8, 10, 13, 16, 18, 21, 24, 30 mm
- 1 socket with male ferrule: 5 mm
- 1 puller

#### • Screw tightening torque

See section 5.4.

#### • Access to diodes

- Open the air intake grille (51).
- Disconnect the diodes.
- Check the 6 diodes, change the diode bridges if necessary.

#### • Access to connections and the regulation system

Access directly by removing the top of the cover (48) or the AVR access door (59).

#### • Replacing the NDE bearing

- Remove the box lid (48), the NDE panel (47) and the side panels (367).
- Disconnect the stator outputs (T1 to T12).
- Disconnect the auxiliary winding wires AREP (X1, X2, Z1, Z2).
- Disconnect the exciter wires (5+, 6-).
- Remove the air inlet louvre (51).

If using a single-bearing or double-bearing machine without the regreasable bearing option:

- Remove the 8 nuts from the tie rods (37).
- Remove the shield (36).
- Take out the antifriction bearing (70) using a puller with a central screw (see drawing below).

If the machine has the regreasable bearing option, start by removing the screws from the bearing stop (78).

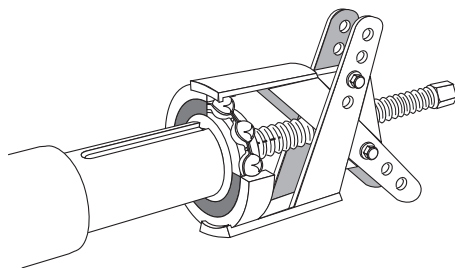

- Fit the new antifriction bearing onto the shaft after heating it by induction to approximately 80 °C.

- Mount the new preloading (wavy) washer (79) + the new "O" ring seal (349) in the shield (36) and coat the bearing seat with adhesive paste (see After Sales Service).

If using a single-bearing or double-bearing machine with the regreasable bearing option:

- Screw a threaded rod into the thrust bearing (78).
- Refit the end shield on the machine using a dowel and nut in the shaft extension (see drawing).

## LSA 46.3

### Low Voltage Alternator - 4 pole

- Slide the threaded rod into the shield hole to make it easier to assemble (see basic diagram).

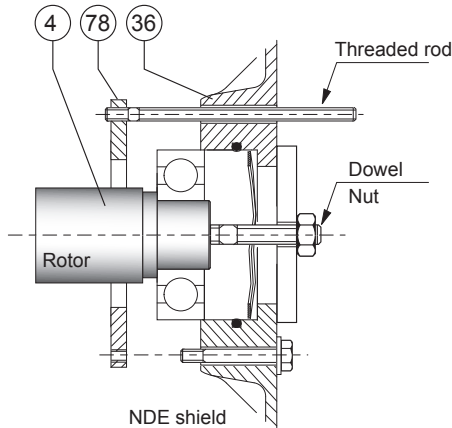

- Fit the thrust bearing screws (78), remove the threaded rod, fit the other screw and tighten up the assembly.  
 - Block the 8 tie rods (37) of the bearing.  
 - Reconnect wires.  
 - Fit the air inlet louvre (51).  
 - Replace the cover.

#### WARNING

**When dismantling the shields, you will need to change the antifriction bearings, the "O" ring seal, the preloading (wavy) washer and adhesive paste.**

#### • Replacing the DE bearing

- Remove the air inlet louvre (51).  
 - Untighten the tie rods (37).  
 - Remove the air outlet grille (33).  
 - Remove the 6 screws (31) from the DE shield and the 3 screws (62) from the inner bearing retainer.  
 - Remove the shield (32).  
 - Take out the ball bearing (60) using a puller with a central screw.  
 - Fit the new bearing, after heating it by induction to approximately 80 °C.  
 - Screw a threaded rod into the thrust bearing (68).

- Refit the shield (32) on the machine.  
 - Slide the threaded rod into the shield hole to make it easier to assemble (see basic diagram).  
 - Tighten the bottom thrust bearing screws (78), remove the threaded rod and fit the other screws.  
 - Block the 6 screws (31) of the bearing before locking the tie rods (37).  
 - Refit the air grille (33) and (51).

#### • Dismantling the rotor assembly

Follow the procedure for dismantling the bearings.

- In a single bearing machine:  
 • remove the SAE washer as per the front bearing (32) removal procedure,  
 • remove the coupling disc (322).  
 - Rest the rotor on one of its poles.  
 - Support the DE rotor (4) with a strap or with a support constructed in accordance with the following drawing.  
 - After extraction of the rotor, be careful not to damage the fan (15) or the booster (19) or dismantle it.  
 - Remove the rotor on special V-shaped supports.

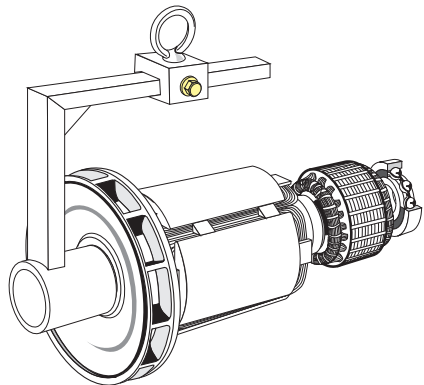

#### WARNING

**When dismantling the rotor involves changing parts or rewinding, the rotor must be rebalanced.**



# LSA 46.3

## Low Voltage Alternator - 4 pole

### • Reassembling the machine

- Follow the dismantling procedure in reverse order.

Take care not to knock the windings when refitting the rotor in the stator.

- In a single or dual bearing machine with regreasable bearing option: apply the regreasable bearing changing procedure.

- Block the 6 screws (31) of the front bearing / SAE washer before tightening the tie rods (37).

- Refit the air grille (33) and (51).

### • Dismantling and reassembly of the filters

- Remove the grille (51) then take out the filter (52). Change the filter if necessary; please refer to section 4.2 for cleaning the filter.

To replace, follow the instructions in reverse order.

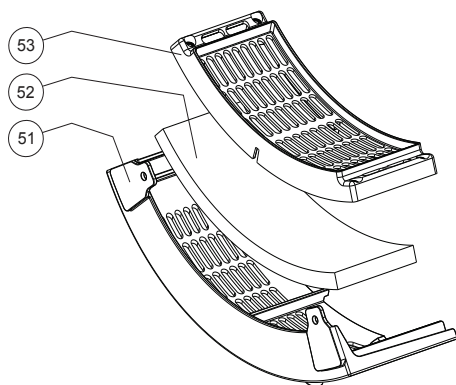

### 4.7 - Installation and maintenance of the PMG

The PMG reference is PMG 2.

See the PMG manual ref : 4211.

### 4.8 - Table of characteristics

Table of average values

Alternator - 4 poles - 50 Hz - Standard winding No. 6 (12-wire)

(400V for the excitation values)

The voltage and current values are given for no-load operation and operation at rated load with separate field excitation.

All values are given to within  $\pm 10\%$  and may be changed without prior notification (for exact values, consult the test report).

#### • Three-phase: 4-pole SHUNT/AREP excitation Resistances at 20 °C ( $\Omega$ )

Type	Stator L/N	Rotor	Exciter field	Exciter armature
S2	0.0254	0.254	14.42	0.033
S3	0.0200	0.270	14.42	0.033
S4/S5	0.0161	0.295	14.42	0.033
M7/M8	0.0120	0.323	15.54	0.035
L10/L11	0.0086	0.383	15.54	0.035

#### Resistances of auxiliary windings AREP at 20 °C ( $\Omega$ )

Type	X1, X2	Z1, Z2
S2	0.337	0.399
S3	0.300	0.461
S4/S5	0.270	0.440
M7/M8	0.289	0.480
L10/L11	0.258	0.404

## LSA 46.3

### Low Voltage Alternator - 4 pole

#### Field excitation current $i_{exc}$ (A)

##### SHUNT/AREP - 400V - 50 Hz

" $i_{exc}$ ": excitation current of the exciter field

Type	No load	At rated load
S2	0.68	2.73
S3	0.76	2.75
S4	0.75	2.75
S5	0.75	2.97
M7	0.9	2.86
M8	0.9	3.08
L10	0.78	2.64
L11	0.78	2.92

For 60 Hz machines, the " $i_{exc}$ " values are approximately 5 to 10 % lower.

#### • Voltage of auxiliary windings at no load

Type	X1, X2	Z1, Z2
S2	104	16
S3	103	12
S4/S5	101	12
M7/M8	123	16
L10/L11	119	12

#### • Table of weights

(values given for information only)

Type	Total weight (kg)	Rotor (kg)
S2	569	245
S3	599	257
S4	674	277
S5	682	277
M7/M8	754	307
L10/L11	888	362



**After operational testing, it is essential to replace all access panels or covers.**

# LSA 46.3

## Low Voltage Alternator - 4 pole

### 5 - SPARE PARTS

#### 5.1 - First maintenance parts

Emergency repair kits are available as an option.

They contain the following items:

<b>Emergency kit SHUNT</b>	<b>4254514</b>
AVR R250	-
Diode bridge assembly	-
Surge suppressor	-

<b>Emergency kit AREP/PMG</b>	<b>5163976</b>
AVR D350	-
Diode bridge assembly	-
Surge suppressor	-

<b>Single-bearing kit</b>	<b>4061227</b>
Non drive end bearing	-
«O» ring	-
Preloading (wavy) washer	-

<b>Double-bearing kit</b>	<b>4061463</b>
Non drive end bearing	-
Drive end bearing	-
«O» ring	-
Preloading (wavy) washer	-

#### 5.2 - Technical support service

Our technical support service will be pleased to provide any additional information you may require.

For all spare parts orders or technical support requests, send your request to [service.epg@leroy-somer.com](mailto:service.epg@leroy-somer.com) or your closest contact, whom you will find at [www.lrsom.co/support](http://www.lrsom.co/support) indicating the complete type of machine, its number and the information indicated on the nameplate.

Part numbers should be identified from the exploded views and their description from the parts list.

To ensure that our products operate correctly and safely, we recommend the use of original manufacturer spare parts.

In the event of failure to comply with this advice, the manufacturer cannot be held responsible for any damage.



**After operational testing, it is essential to replace all access panels or covers.**

#### 5.3 - Accessories

##### • Space heater for use when stopped

The space heater must run as soon as the alternator stops. It is installed at the rear of the machine. Its standard power is 250W with 220V or 250W with 110V on request.



**Warning: the power supply is present when the machine has stopped.**

##### • Temperature sensors with thermistors (PTC)

These are thermistor triplets with a positive temperature coefficient installed in the stator winding (1 per phase). There can be a maximum of 2 triplets in the winding (at 2 levels: warning and trip) and 1 or 2 thermistors in the shields.

These sensors must be linked to adapted sensing relays (supplied optionally).

Cold resistance of cold thermistor sensors: 100 to 250  $\Omega$  per sensor.

##### • Connection accessories

- 6-wire machines : coupling (F)
- 12-wire machines : coupling (A), (F.F), (F).

# LSA 46.3

## Low Voltage Alternator - 4 pole

### 5.4 - Exploded view, parts list and tightening torque

#### • Single-bearing

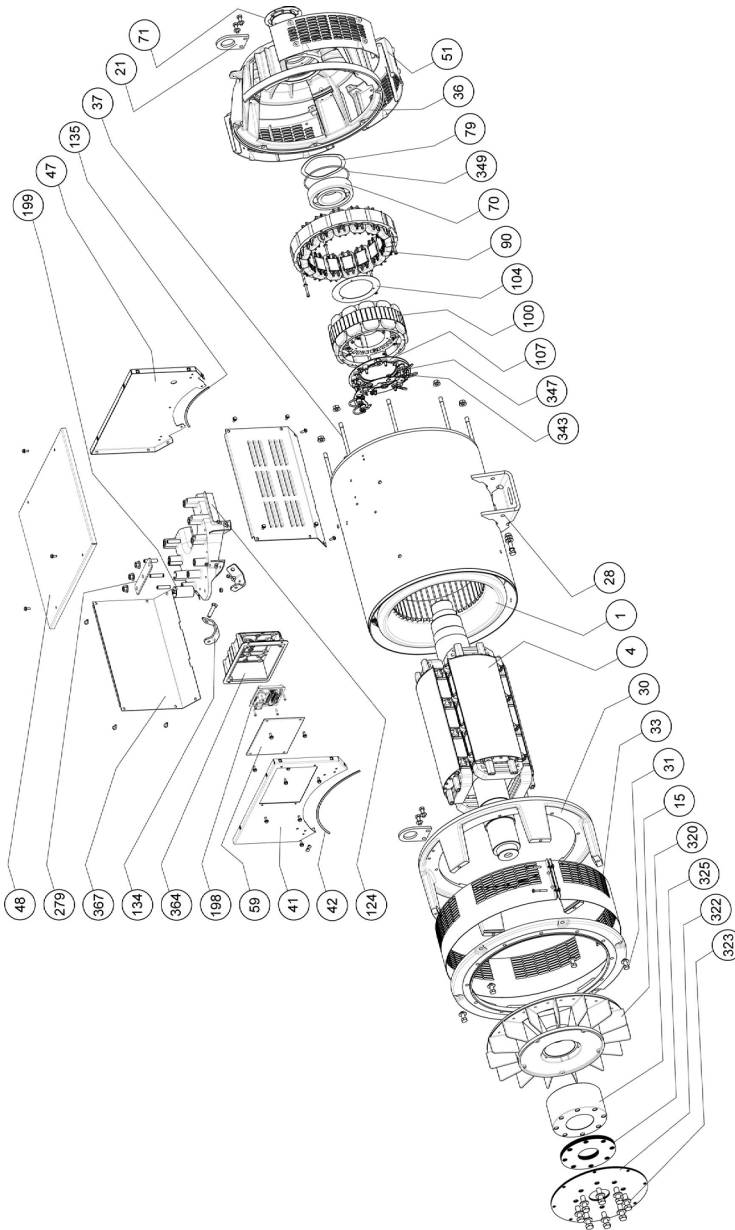

# LSA 46.3

## Low Voltage Alternator - 4 pole

### • Double-bearing

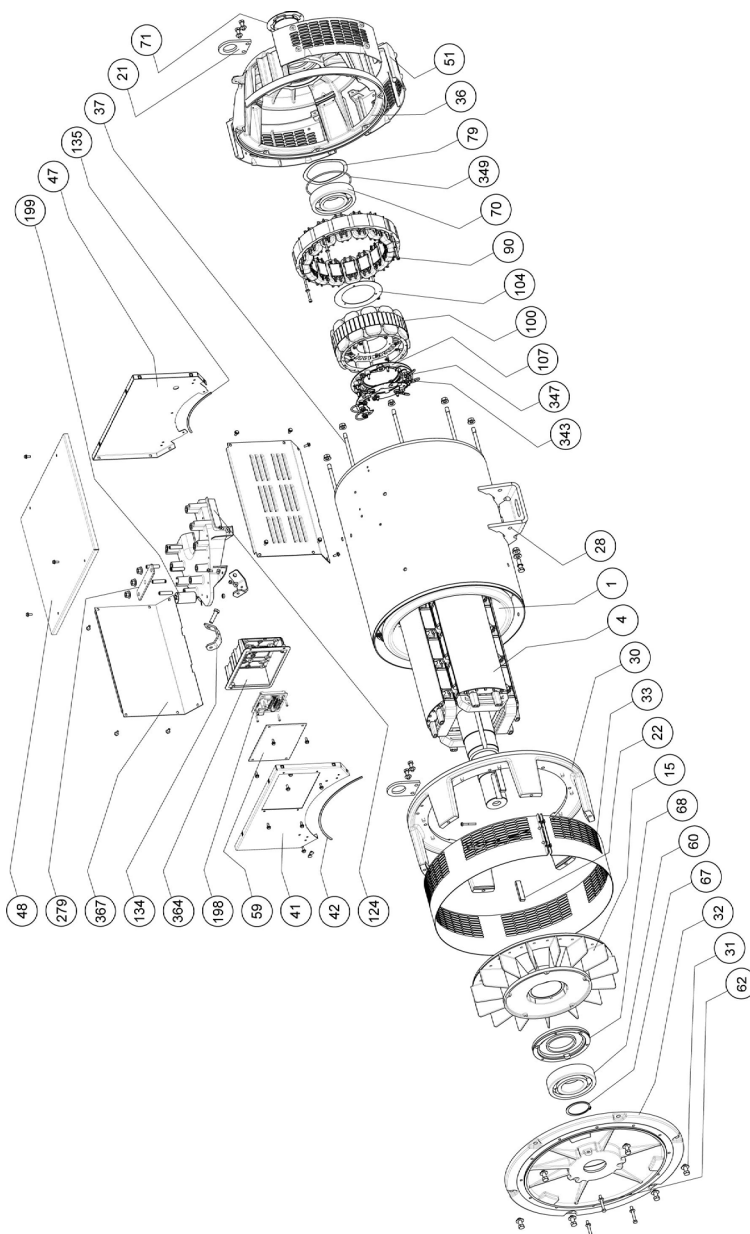

## LSA 46.3

### Low Voltage Alternator - 4 pole

Ref.	Qty	Description	Screw Ø	Torque N.m	Ref.	Qty	Description	Screw Ø	Torque N.m
1	1	Stator assembly	-	-	70	1	Non drive end (NDE) bearing	-	-
4	1	Rotor assembly	-	-	71	1	Outer bearing retainer	-	-
15	1	Fan	-	-	79	1	Preloading (wavy) washer	-	-
21	1	Lifting eye	M10	40	90	1	Exciter field (stator)	-	-
22	1	Shaft extension key	-	-	100	1	Exciter armature (rotor)	-	-
28	1	Earth terminal	M10	24	104	1	Washer	-	-
30	1	Drive end (DE) shield	-	-	107	1	Diode support ring	-	-
31	6	Fixing bolts	M12	75	124	1	Terminal block	M6	10
32	1	S.A.E. adaptor ring	M12	75	134	1	Panel fixing	M6	10
33	1	Protective guard	M6	8	135	1	Drive end (DE) terminal box seal	-	-
36	1	Non drive end (NDE) shield	M12	75	198	1	Voltage regulator (AVR)	M5	6
37	8	Tie rod	-	-	199	1	Interference suppression module (RFI kit)	-	-
41	1	Terminal box front panel	M6	8	279	6 / 8	Connection bar	-	-
42	1	Drive end (DE) terminal box seal	-	-	320	1	Coupling sleeve	-	-
47	1	Non drive end (NDE) terminal box seal	M6	8	322	3	Coupling discs	-	-
48	1	Terminal box lid	M6	8	323	6	Fixing bolts	M16	170
51	1	Air intake guard	M6	8	325	-	Spacer shims	-	-
59	1	AVR access panel	M6	4	343	1	Diode bridge assembly	M5	6
60	1	Drive end (DE) bearing	-	-	347	1	Surge suppressor (+ PCB)	-	-
62	3	Fixing bolts	M8	20	349	1	O ring seal	-	-
67	1	Circlips	-	-	364	1	AVR support	M6	8
68	1	Inner bearing retainer	-	-	367	2	Terminal box side panel	M6	8

# LSA 46.3

## Low Voltage Alternator - 4 pole

### Disposal and recycling instructions

We are committed to limiting the environmental impact of our activity. We continuously monitor our production processes, material sourcing and product design to improve recyclability and minimise our environmental footprint.

These instructions are for information purposes only. It is the user's responsibility to comply with local legislation regarding product disposal and recycling.

### Recyclable materials

Our alternators are mainly constructed from iron, steel and copper materials, which can be reclaimed for recycling purposes.

These materials can be reclaimed through a combination of manual dismantling, mechanical separation and melting processes. Our technical support department can provide detailed directions on how to dismantle products on request.

### Waste & hazardous materials

The following components and materials require special treatment and must be separated from the alternator before the recycling process:

- electronic materials found in the terminal box, including the automatic voltage regulator (198), current transformers (176), interference suppression module (199) and other semi-conductors.
- diode bridge (343) and surge suppressor (347), found on the alternator rotor.
- major plastic components, such as the terminal box structure on some products. These components are usually marked with information concerning the type of plastic.

All materials listed above need special treatment to separate waste from reclaimable materials and should be entrusted to specialist recycling companies.

The oil and grease from the lubrication system should be treated as hazardous waste and must be treated in accordance with local legislation.

# LSA 46.3

## Low Voltage Alternator - 4 pole



# LSA 46.3

## Low Voltage Alternator - 4 pole

### Declaration of EC compliance and incorporation

This Declaration applies to the generators designed to be incorporated into machines complying with the Machinery Directive Nr 2006/42/EC dated 17 May 2006.

MOTEURS LEROY-SOMER Boulevard Marcellin Leroy 16015 ANGOULEME FRANCE	MLS HOLICE STLO.SRO SLADKOVSKOHO 43 772 04 OLOMOUC CZECH REPUBLIC	MOTEURS LEROY-SOMER 1, rue de la Buelle Boite Postale 1517 45800 ST JEAN DE BRAYE FRANCE	DIVISION LEROY-SOMER STREET EMERSON Nr4 Parcul Industrial Tetarom 2 4000641 CLUJ NAPOCA ROMANIA
---	--	--	---

Declares hereby that the electric generators of the types:

LSA40, LSA42.3, LSA44.2, LSA44.3, LSA46.2, LSA46.3, LSA47.2, LSA49.1, LSA49.3, LSA50.1, LSA50.2, LSA51.2, LSA52.2, LSA52.3, LSA53.1, LSA53, LSA53.2, LSA54, LSA54.2, TAL040, TAL042, TAL044, TAL046, TAL047, TAL049, as well as their derivatives, manufactured by Leroy-Somer or on Leroy-Somer's behalf, comply with the following International Standards and Directive:

- EN and IEC 60034-1, 60034-5 and 60034-22
- ISO 8528-3 "Reciprocating internal combustion engine driven alternating current generating sets. Part 3. Alternating current generators for generating sets"
- Low Voltage Directive Nr 2014/35/UE dated 26 February 2014

Furthermore, these generators, designed in compliance with the Machine Directive Nr 2006/42, are therefore able to be incorporated into Electrical Gen-Sets complying with the following International Directives:

- Machinery Directive Nr 2006/42/EC dated 17 May 2006
- EMC Directive Nr 2014/30/UE dated 26 February 2014, as intrinsic levels of emissions and immunity are concerned

#### WARNING:

The here mentioned generators should not be commissioned until the corresponding Gen-Sets have been declared in compliance with the Directives Nr 2006/42/EC and 2014/30/UE, as well as with the other relevant Directives.

Leroy-Somer undertakes to transmit, in response to a reasoned request by the national authorities, relevant information on the generator.

Technical Managers  
J.P. CHARPENTIER Y. MESSIN

4152 en - 2017.05 / m

*The contractual EC Declaration of Conformity and Incorporation can be obtained from your contact on request.*

# LSA 46.3

## Low Voltage Alternator - 4 pole

# Service & Support

Our worldwide service network of over 80 facilities is at your service.

This local presence is our guarantee for fast and efficient repair, support and maintenance services.

Trust your alternator maintenance and support to electric power generation experts. Our field personnel are 100% qualified and fully trained to operate in all environments and on all machine types.

We have a deep understanding of alternator operation, providing the best value service to optimise your cost of ownership.

Where we can help:

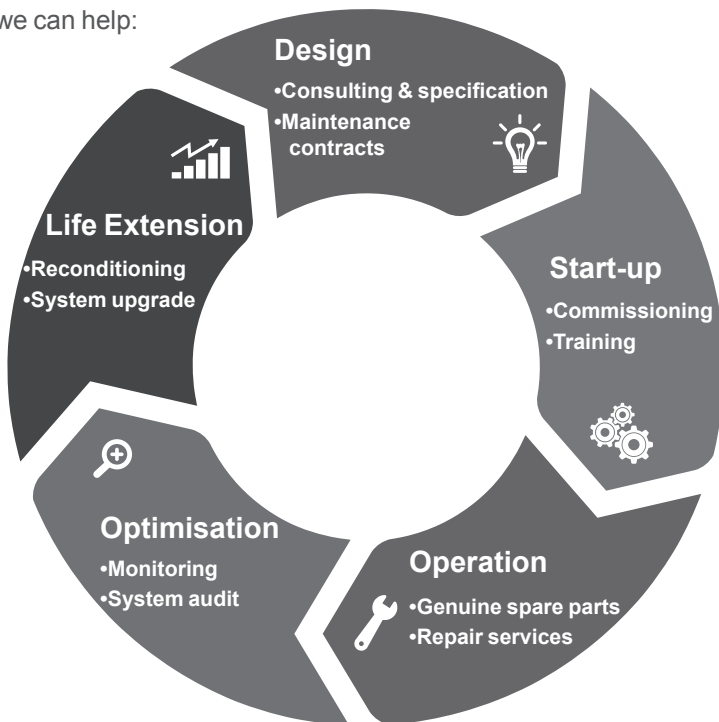

Contact us:

**Americas:** +1 (507) 625 4011

**Europe & Rest of the world:** +33 238 609 908

**Asia Pacific:** +65 6250 8488

**China:** +86 591 88373036

**India:** +91 806 726 4867

**Middle East:** +971 4 5687431



Scan the code or go to:

 [service.epg@leroy-somer.com](mailto:service.epg@leroy-somer.com)

[www.lrsr.co/support](http://www.lrsr.co/support)

**LEROY-SOMER**<sup>™</sup>

[www.leroy-somer.com/epg](http://www.leroy-somer.com/epg)

[Linkedin.com/company/Leroy-Somer](https://www.linkedin.com/company/Leroy-Somer)

[Twitter.com/Leroy\\_Somer\\_en](https://twitter.com/Leroy_Somer_en)

[Facebook.com/LeroySomer.Nidec.en](https://www.facebook.com/LeroySomer.Nidec.en)

[YouTube.com/LeroySomerOfficiel](https://www.youtube.com/LeroySomerOfficiel)



***Nidec***  
All for dreams