

**COMPLEX SOLUTIONS
MADE SIMPLE**



DEEP SEA ELECTRONICS PLC

DSE704

AUTOSTART CONTROL MODULE

OPERATING MANUAL



Deep Sea Electronics Plc
Highfield House
Hunmanby
North Yorkshire
YO14 0PH
ENGLAND

Sales Tel: +44 (0) 1723 890099
Sales Fax: +44 (0) 1723 893303

E-mail: sales@Deepseapl.com
Website: www.deepseapl.com

DSE Model 704 Control System Operators Manual

© Deep Sea Electronics Plc

All rights reserved. No part of this publication may be reproduced in any material form (including photocopying or storing in any medium by electronic means or other) without the written permission of the copyright holder except in accordance with the provisions of the Copyright, Designs and Patents Act 1988.

Applications for the copyright holder's written permission to reproduce any part of this publication should be addressed to Deep Sea Electronics Plc at the address above.

Any reference to trademarked product names used within this publication is owned by their respective companies.

Deep Sea Electronics Plc reserves the right to change the contents of this document without prior notice.

TABLE OF CONTENTS

1 DESCRIPTION OF OPERATION	4
1.1MANUAL MODE OPERATION.....	4
1.2AUTOMATIC MODE OF OPERATION.....	5
1.3WARNINGS.....	6
1.4SHUTDOWNS	6
2 CONFIGURATION INSTRUCTIONS.....	7
3 CONFIGURATION TABLES	8
4 TERMINAL DESCRIPTION.....	12
5 SPECIFICATION.....	13
6 SOLID STATE OUTPUTS.....	14
7 DIMENSIONS.....	15
8 TYPICAL CONNECTIONS.....	15

1 DESCRIPTION OF OPERATION

1.1 MANUAL MODE OPERATION

To initiate a start sequence in **MANUAL**, press the  pushbutton, and the start sequence is initiated.

 **NOTE:- There is no Start Delay in this mode of operation.**

If the **pre-heat** output option is selected this timer is then initiated, and the auxiliary output selected is energised.

After the above delay the **Fuel Solenoid** is energised, then the **Starter Motor** is engaged.

The engine is cranked for a 10 second period. If the engine fails to fire during this cranking attempt then the starter motor is disengaged for a 10 second period. Should this sequence continue beyond the 3 starting attempts, the start sequence will be terminated and **Fail to Start**  fault will be illuminated.

When the engine fires, the starter motor is disengaged and locked out at 20 Hz measured from the Alternator output. Rising oil pressure can also be used to disconnect the starter motor, however it cannot be used for underspeed or overspeed detection.

After the starter motor has disengaged, the **Safety On** timer is activated (which is fixed at 12 seconds), allowing Oil Pressure, High Engine Temperature, Under-speed, Charge Fail and any delayed Auxiliary fault inputs to stabilise without triggering the fault.

Once the engine is running, the **Warm Up** timer, if selected, is initiated, allowing the engine to stabilise before it can be loaded.

The generator will run off load, unless the mains supply fails or a **Remote Start on load** signal is applied, at which point the load will be transferred to the generator.

The generator will continue to run **On** load regardless of the state of the mains supply or remote start input until the **Auto** mode is selected.

If Auto mode is selected, and the mains supply is healthy with the remote start on load signal not active, then the **Remote Stop Delay Timer** begins, after which, the load is disconnected. The generator will then run **off** load allowing the engine a **cooling** down period.

Selecting **STOP**  de-energises the **FUEL SOLENOID**, bringing the generator to a stop.

 **NOTE:- The safety on time (used for delayed alarms) is pre set to 12 seconds and can not be changed.**

1.2 AUTOMATIC MODE OF OPERATION

This mode is activated by pressing the  pushbutton. An LED indicator beside the button confirms this action.

Whether the start sequence is initiated by mains (utility) failure or by remote start input, the following sequence is followed:

To allow for short term mains supply transient conditions or false remote start signals, the Start Delay timer is initiated. After this delay, if the pre-heat output option is selected then the pre-heat timer is initiated, and the corresponding auxiliary output (if configured) will energise.

NOTE:- If the mains supply returns within limits, (or the Remote Start signal is removed if the start sequence was initiated by remote start) during the Start Delay timer, the unit will return to a stand-by state.

After the above delays the **Fuel Solenoid** is energised, then one second later, the **Starter Motor** is engaged.

The engine is cranked for a 10 second period. If the engine fails to fire during this cranking attempt then the starter motor is disengaged for a 10 second rest period. Should this sequence continue beyond the 3 starting attempts, the start sequence will be terminated and

Fail to Start  fault will be illuminated.

When the engine fires, the starter motor is disengaged and locked out at 20 Hz measured from the Alternator output. Rising oil pressure can also be used to disconnect the starter motor, however it cannot be used for underspeed or overspeed detection.

After the starter motor has disengaged, the **Safety On** timer is activated, allowing Oil Pressure, High Engine Temperature, Under-speed, Charge Fail and any delayed Auxiliary fault inputs to stabilise without triggering the fault.

Once the engine is running, the **Warm Up** timer, if selected is initiated, allowing the engine to stabilise before accepting the load.

If the remote start is being used and has been configured to **Remote start is on load**, or the mains has failed, the load will be transferred to the generator.

On the return of the mains supply, (or removal of the **Remote Start** signal if the set was started by remote signal), the **Stop** delay timer is initiated. Once it has timed out, the load is transferred back to the mains (utility). The **Cooling** timer is then initiated, allowing the engine a cooling down period off load before shutting down. Once the **Cooling** timer expires the **Fuel Solenoid** is de-energised, bringing the generator to a stop.

If the mains should fail (or a **Remote Start** signal is re-activated) whilst the generator is **Cooling** down, the load will be immediately transferred to the generator.

Should the mains supply fall outside limits again (or the **Remote Start** signal be re-activated) during the cooling down period, the set will return on load.

NOTE:- The safety on time (used for delayed alarms) is pre set to 12 seconds and can not be changed.

1.3 WARNINGS

Warnings are used to warn the operator of an impending fault

BATTERY CHARGE FAILURE, if the module does not detect a voltage from the warning light terminal on the auxiliary charge alternator, the  icon will illuminate. (Either 8 Volts or 16 Volts depending on the configuration of **Nominal DC Voltage**).

Inputs 1 and 2 can be configured as warnings or shutdowns. The relevant icon will be illuminated when the input is active

1.4 SHUTDOWNS

Shutdowns are latching and stop the Generator. The alarm must be cleared, and the fault removed to reset the module. In the event of a shutdown the appropriate icon will be illuminated

 **NOTE:- The alarm condition must be rectified before a reset will take place. If the alarm condition remains it will not be possible to reset the unit (The exception to this is the Low Oil Pressure alarm and similar 'delayed alarms', as the oil pressure will be low with the engine at rest). Any subsequent warnings or shutdowns that occur will be displayed steady, therefore only the first-up shutdown will appear flashing.**

 **NOTE:- The safety on time (used for delayed alarms) is pre set to 12 seconds and can not be changed.**

FAIL TO START, if the engine does not fire after the pre-set 3 attempts at starting, a shutdown will be initiated.

The  icon will illuminate.

LOW OIL PRESSURE, if the module detects that the engine oil pressure has fallen below the low oil pressure switch after the **Safety On** timer has expired, a shutdown will occur.

The  icon will illuminate.

HIGH ENGINE TEMPERATURE if the module detects that the engine coolant temperature has exceeded the high engine temperature switch after the **Safety On** timer has expired, a shutdown will occur.

The  icon will illuminate.

OVERSPEED, if the engine speed exceeds the pre-set trip (14% above the nominal frequency) a shutdown is initiated. Overspeed is not delayed, it is an **immediate shutdown**.

The  icon will illuminate.

 **NOTE:- During the start-up sequence the overspeed trip level is extended to 24% above the normal frequency for the duration of the safety timer to allow an extra trip level margin. This is used to prevent nuisance tripping on start-up.**

UNDERSPEED, if the engine speed falls below the pre-set trip (20% of the nominal frequency) after the **Safety On** timer has expired, a shutdown is initiated.



The  icon will illuminate.

Inputs 1 and 2 can be configured as warnings or shutdowns. The relevant icon will be illuminated when the input is active

2 CONFIGURATION INSTRUCTIONS

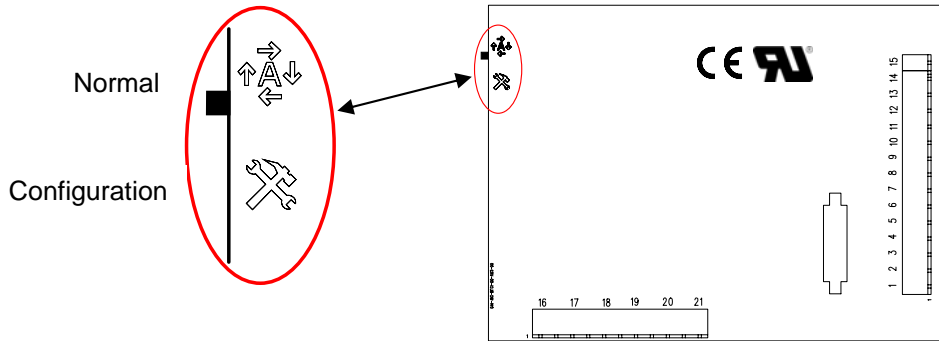
- ◆ With the unit in **Stop**  mode, **Configuration Mode** is selected by operation of a small switch on the rear, left-hand edge of the PCB. This is partially hidden to prevent accidental operation.



- ◆ Once **Configuration Mode** is selected, the 'Auto' LED will commence rapid flashing, and all normal operation is suspended.
- ◆ The **Stop**  pushbutton can be used to select the LED 'code' that corresponds to the required function. The 5 left-hand LED's will form the code. See configuration table over leaf.
- ◆ The **Manual**  pushbutton will allow the user to change the associated value. The 3 right-hand LED's inform the user of the current setting for the chosen function. See configuration table over leaf.
- ◆ When the required parameters are displayed, pressing the **Auto**  button will save the new setting, and the process is repeated for each function change.
- ◆ When configuration is complete, the **Configuration Mode** Selector Switch should be returned to the 'Normal' position.

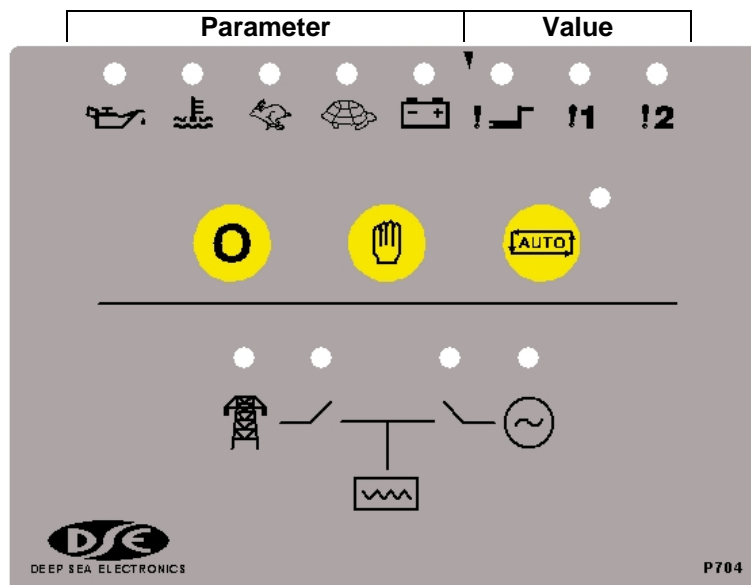

3 CONFIGURATION TABLES

FUNCTIONS AND CONFIGURATION TABLE									
Function						! 1	! 2	Value (Default in Bold)	
Pre-heat Timer	<input type="radio"/>	<input type="radio"/>	<input type="radio"/>	<input type="radio"/>	<input checked="" type="radio"/>	<input type="radio"/>	<input type="radio"/>	<input type="radio"/>	0 Seconds
	<input type="radio"/>	<input type="radio"/>	<input type="radio"/>	<input type="radio"/>	<input type="radio"/>	<input type="radio"/>	<input type="radio"/>	<input checked="" type="radio"/>	5 Seconds
	<input type="radio"/>	<input type="radio"/>	<input type="radio"/>	<input type="radio"/>	<input type="radio"/>	<input checked="" type="radio"/>	<input type="radio"/>	<input type="radio"/>	10 Seconds
	<input type="radio"/>	<input type="radio"/>	<input type="radio"/>	<input type="radio"/>	<input type="radio"/>	<input checked="" type="radio"/>	<input checked="" type="radio"/>	<input checked="" type="radio"/>	15 Seconds
	<input checked="" type="radio"/>	<input type="radio"/>	<input type="radio"/>	<input type="radio"/>	<input type="radio"/>	<input type="radio"/>	<input type="radio"/>	<input type="radio"/>	20 Seconds
	<input checked="" type="radio"/>	<input type="radio"/>	<input type="radio"/>	<input type="radio"/>	<input type="radio"/>	<input type="radio"/>	<input checked="" type="radio"/>	<input checked="" type="radio"/>	30 Seconds
	<input checked="" type="radio"/>	<input type="radio"/>	<input type="radio"/>	<input type="radio"/>	<input type="radio"/>	<input checked="" type="radio"/>	<input type="radio"/>	<input type="radio"/>	60 Seconds
<input checked="" type="radio"/>	<input checked="" type="radio"/>	<input checked="" type="radio"/>	<input checked="" type="radio"/>	<input checked="" type="radio"/>	<input checked="" type="radio"/>	<input checked="" type="radio"/>	<input checked="" type="radio"/>	180 Seconds	
Used to pre-heat the engine prior to cranking. The output is active for the duration of the setting, prior to cranking.									

Start Delay	<input type="radio"/>	<input type="radio"/>	<input type="radio"/>	<input checked="" type="radio"/>	<input type="radio"/>	<input type="radio"/>	<input type="radio"/>	<input type="radio"/>	0 Seconds
	<input type="radio"/>	<input type="radio"/>	<input type="radio"/>	<input type="radio"/>	<input type="radio"/>	<input type="radio"/>	<input checked="" type="radio"/>	<input checked="" type="radio"/>	5 Seconds
	<input type="radio"/>	<input type="radio"/>	<input type="radio"/>	<input type="radio"/>	<input type="radio"/>	<input checked="" type="radio"/>	<input type="radio"/>	<input type="radio"/>	10 Seconds
	<input type="radio"/>	<input type="radio"/>	<input type="radio"/>	<input type="radio"/>	<input type="radio"/>	<input checked="" type="radio"/>	<input checked="" type="radio"/>	<input checked="" type="radio"/>	15 Seconds
	<input checked="" type="radio"/>	<input type="radio"/>	<input type="radio"/>	<input type="radio"/>	<input type="radio"/>	<input type="radio"/>	<input type="radio"/>	<input type="radio"/>	20 Seconds
	<input checked="" type="radio"/>	<input type="radio"/>	<input type="radio"/>	<input type="radio"/>	<input type="radio"/>	<input type="radio"/>	<input checked="" type="radio"/>	<input checked="" type="radio"/>	30 Seconds
	<input checked="" type="radio"/>	<input type="radio"/>	<input type="radio"/>	<input type="radio"/>	<input type="radio"/>	<input checked="" type="radio"/>	<input type="radio"/>	<input type="radio"/>	60 Seconds
<input checked="" type="radio"/>	<input checked="" type="radio"/>	<input checked="" type="radio"/>	<input checked="" type="radio"/>	<input checked="" type="radio"/>	<input checked="" type="radio"/>	<input checked="" type="radio"/>	<input checked="" type="radio"/>	180 Seconds	
Used to give a delay between activating the remote start input, or a mains failure, and actually starting the engine.									

Stop Delay Mains Return Delay	<input type="radio"/>	<input type="radio"/>	<input type="radio"/>	<input checked="" type="radio"/>	<input checked="" type="radio"/>	<input type="radio"/>	<input type="radio"/>	<input type="radio"/>	0 Seconds
	<input type="radio"/>	<input type="radio"/>	<input type="radio"/>	<input type="radio"/>	<input type="radio"/>	<input type="radio"/>	<input type="radio"/>	<input checked="" type="radio"/>	5 Seconds
	<input type="radio"/>	<input type="radio"/>	<input type="radio"/>	<input type="radio"/>	<input type="radio"/>	<input checked="" type="radio"/>	<input type="radio"/>	<input type="radio"/>	10 Seconds
	<input type="radio"/>	<input type="radio"/>	<input type="radio"/>	<input type="radio"/>	<input type="radio"/>	<input checked="" type="radio"/>	<input checked="" type="radio"/>	<input checked="" type="radio"/>	15 Seconds
	<input checked="" type="radio"/>	<input type="radio"/>	<input type="radio"/>	<input type="radio"/>	<input type="radio"/>	<input type="radio"/>	<input type="radio"/>	<input type="radio"/>	20 Seconds
	<input checked="" type="radio"/>	<input type="radio"/>	<input type="radio"/>	<input type="radio"/>	<input type="radio"/>	<input type="radio"/>	<input checked="" type="radio"/>	<input checked="" type="radio"/>	30 Seconds
	<input checked="" type="radio"/>	<input checked="" type="radio"/>	<input checked="" type="radio"/>	<input checked="" type="radio"/>	<input checked="" type="radio"/>	<input checked="" type="radio"/>	<input type="radio"/>	<input type="radio"/>	60 Seconds
<input checked="" type="radio"/>	<input checked="" type="radio"/>	<input checked="" type="radio"/>	<input checked="" type="radio"/>	<input checked="" type="radio"/>	<input checked="" type="radio"/>	<input checked="" type="radio"/>	<input checked="" type="radio"/>	180 Seconds	
Used to give a delay between the mains returning and the system switching the load back to the mains. Used to ensure that the mains is steady before this action is executed.									

Energise to Stop Hold Timer	<input type="radio"/>	<input type="radio"/>	<input checked="" type="radio"/>	<input type="radio"/>	<input type="radio"/>	<input type="radio"/>	<input type="radio"/>	<input type="radio"/>	0 Seconds
	<input type="radio"/>	<input type="radio"/>	<input type="radio"/>	<input type="radio"/>	<input type="radio"/>	<input type="radio"/>	<input type="radio"/>	<input checked="" type="radio"/>	5 Seconds
	<input type="radio"/>	<input type="radio"/>	<input type="radio"/>	<input type="radio"/>	<input type="radio"/>	<input checked="" type="radio"/>	<input type="radio"/>	<input type="radio"/>	10 Seconds
	<input type="radio"/>	<input type="radio"/>	<input type="radio"/>	<input type="radio"/>	<input type="radio"/>	<input checked="" type="radio"/>	<input checked="" type="radio"/>	<input checked="" type="radio"/>	15 Seconds
	<input checked="" type="radio"/>	<input type="radio"/>	<input type="radio"/>	<input type="radio"/>	<input type="radio"/>	<input type="radio"/>	<input type="radio"/>	<input type="radio"/>	20 Seconds
	<input checked="" type="radio"/>	<input type="radio"/>	<input type="radio"/>	<input type="radio"/>	<input type="radio"/>	<input type="radio"/>	<input checked="" type="radio"/>	<input checked="" type="radio"/>	30 Seconds
	<input checked="" type="radio"/>	<input checked="" type="radio"/>	<input checked="" type="radio"/>	<input checked="" type="radio"/>	<input checked="" type="radio"/>	<input checked="" type="radio"/>	<input type="radio"/>	<input type="radio"/>	60 Seconds
<input checked="" type="radio"/>	<input checked="" type="radio"/>	<input checked="" type="radio"/>	<input checked="" type="radio"/>	<input checked="" type="radio"/>	<input checked="" type="radio"/>	<input checked="" type="radio"/>	<input checked="" type="radio"/>	180 Seconds	
Used for the control of the engine stop solenoid. When the engine is to be stopped, the Energise To Stop output becomes active, closing the stop solenoid (fuel valve). When the engine comes to rest, the stop solenoid will remain energised for the period of the Energise To Stop Timer, to ensure the engine has come to a complete stop.									

Warm-up Timer	<input type="radio"/>	<input type="radio"/>	<input checked="" type="radio"/>	<input type="radio"/>	<input checked="" type="radio"/>	<input type="radio"/>	<input type="radio"/>	<input type="radio"/>	0 Seconds
	<input type="radio"/>	<input type="radio"/>	<input type="radio"/>	<input type="radio"/>	<input type="radio"/>	<input type="radio"/>	<input type="radio"/>	<input checked="" type="radio"/>	5 Seconds
	<input type="radio"/>	<input type="radio"/>	<input type="radio"/>	<input type="radio"/>	<input type="radio"/>	<input checked="" type="radio"/>	<input type="radio"/>	<input type="radio"/>	10 Seconds
	<input type="radio"/>	<input type="radio"/>	<input type="radio"/>	<input type="radio"/>	<input type="radio"/>	<input checked="" type="radio"/>	<input checked="" type="radio"/>	<input checked="" type="radio"/>	15 Seconds
	<input checked="" type="radio"/>	<input type="radio"/>	<input type="radio"/>	<input type="radio"/>	<input type="radio"/>	<input type="radio"/>	<input type="radio"/>	<input type="radio"/>	20 Seconds
	<input checked="" type="radio"/>	<input type="radio"/>	<input type="radio"/>	<input type="radio"/>	<input type="radio"/>	<input type="radio"/>	<input checked="" type="radio"/>	<input checked="" type="radio"/>	30 Seconds
	<input checked="" type="radio"/>	<input checked="" type="radio"/>	<input checked="" type="radio"/>	<input checked="" type="radio"/>	<input checked="" type="radio"/>	<input checked="" type="radio"/>	<input type="radio"/>	<input type="radio"/>	60 Seconds
<input checked="" type="radio"/>	<input checked="" type="radio"/>	<input checked="" type="radio"/>	<input checked="" type="radio"/>	<input checked="" type="radio"/>	<input checked="" type="radio"/>	<input checked="" type="radio"/>	<input checked="" type="radio"/>	180 Seconds	
Delay between the engine being available for use, and the closure of the generator load-switching device to allow time for the engine to warm before being loaded. This occurs after the 12 second safety on timer.									

Cooling Timer	<input type="radio"/>	<input type="radio"/>	<input checked="" type="radio"/>	<input checked="" type="radio"/>	<input type="radio"/>	<input type="radio"/>	<input type="radio"/>	<input type="radio"/>	0 Seconds
	<input type="radio"/>	<input type="radio"/>	<input type="radio"/>	<input type="radio"/>	<input type="radio"/>	<input type="radio"/>	<input type="radio"/>	<input checked="" type="radio"/>	5 Seconds
	<input type="radio"/>	<input type="radio"/>	<input type="radio"/>	<input type="radio"/>	<input type="radio"/>	<input checked="" type="radio"/>	<input type="radio"/>	<input type="radio"/>	10 Seconds
	<input type="radio"/>	<input type="radio"/>	<input type="radio"/>	<input type="radio"/>	<input type="radio"/>	<input checked="" type="radio"/>	<input checked="" type="radio"/>	<input checked="" type="radio"/>	15 Seconds
	<input checked="" type="radio"/>	<input type="radio"/>	<input type="radio"/>	<input type="radio"/>	<input type="radio"/>	<input type="radio"/>	<input type="radio"/>	<input type="radio"/>	20 Seconds
	<input checked="" type="radio"/>	<input type="radio"/>	<input type="radio"/>	<input type="radio"/>	<input type="radio"/>	<input type="radio"/>	<input checked="" type="radio"/>	<input checked="" type="radio"/>	30 Seconds
	<input checked="" type="radio"/>	<input checked="" type="radio"/>	<input checked="" type="radio"/>	<input checked="" type="radio"/>	<input checked="" type="radio"/>	<input checked="" type="radio"/>	<input type="radio"/>	<input type="radio"/>	60 Seconds
<input checked="" type="radio"/>	<input checked="" type="radio"/>	<input checked="" type="radio"/>	<input checked="" type="radio"/>	<input checked="" type="radio"/>	<input checked="" type="radio"/>	<input checked="" type="radio"/>	<input checked="" type="radio"/>	180 Seconds	
Delay between opening the generator load-switching device and stopping the engine to allow time for the engine to cool down before being stopped. This is particularly useful when used in conjunction with turbo-charged engines.									

FUNCTIONS AND CONFIGURATION TABLE									
Function							I 1	I 2	Value (Default in Bold)
Nominal Frequency	<input type="radio"/>	<input checked="" type="radio"/>	<input type="radio"/>	<input type="radio"/>	<input type="radio"/>	<input type="radio"/>	<input type="radio"/>	<input type="radio"/>	50 Hz (O/S +14% / Overshoot +24%)
	<input type="radio"/>	<input type="radio"/>	<input type="radio"/>	<input type="radio"/>	<input type="radio"/>	<input type="radio"/>	<input type="radio"/>	<input checked="" type="radio"/>	60 Hz (O/S +14% / Overshoot +24%)
The systems nominal frequency. Either 50 Hz or 60 Hz									
Nominal DC Voltage	<input type="radio"/>	<input checked="" type="radio"/>	<input type="radio"/>	<input type="radio"/>	<input checked="" type="radio"/>	<input type="radio"/>	<input type="radio"/>	<input type="radio"/>	12V DC (CF 8V)
	<input type="radio"/>	<input type="radio"/>	<input type="radio"/>	<input type="radio"/>	<input type="radio"/>	<input type="radio"/>	<input type="radio"/>	<input checked="" type="radio"/>	24V DC (CF 16V)
The generator battery voltage. Either 12 Volts or 24 Volts. It is used for the charge alternator failure level.									
LOP Switch Contact	<input type="radio"/>	<input checked="" type="radio"/>	<input type="radio"/>	<input checked="" type="radio"/>	<input type="radio"/>	<input type="radio"/>	<input type="radio"/>	<input type="radio"/>	Close on Fault
	<input type="radio"/>	<input type="radio"/>	<input type="radio"/>	<input type="radio"/>	<input type="radio"/>	<input type="radio"/>	<input type="radio"/>	<input checked="" type="radio"/>	Open on Fault
Configuration for the oil pressure switch. Either to close to battery negative on a fault, or open on a fault.									
HET Switch Contact	<input type="radio"/>	<input checked="" type="radio"/>	<input type="radio"/>	<input checked="" type="radio"/>	<input checked="" type="radio"/>	<input type="radio"/>	<input type="radio"/>	<input type="radio"/>	Close on Fault
	<input type="radio"/>	<input type="radio"/>	<input type="radio"/>	<input type="radio"/>	<input type="radio"/>	<input type="radio"/>	<input type="radio"/>	<input checked="" type="radio"/>	Open on Fault
Configuration for the coolant temperature switch. Either to close to battery negative on a fault, or open on a fault.									
Crank disconnect on Oil Pressure	<input type="radio"/>	<input checked="" type="radio"/>	<input checked="" type="radio"/>	<input type="radio"/>	<input type="radio"/>	<input type="radio"/>	<input type="radio"/>	<input type="radio"/>	Disabled
	<input type="radio"/>	<input type="radio"/>	<input type="radio"/>	<input type="radio"/>	<input type="radio"/>	<input type="radio"/>	<input type="radio"/>	<input checked="" type="radio"/>	Enabled (2 Second Delay)
If this is enabled, the starter motor will disconnect 2 seconds after the oil pressure switch detects oil pressure. NOTE:- Not suitable for all generators, due to the different monitoring points on lubrication systems.									
Underspeed Detection	<input type="radio"/>	<input checked="" type="radio"/>	<input checked="" type="radio"/>	<input type="radio"/>	<input checked="" type="radio"/>	<input type="radio"/>	<input type="radio"/>	<input type="radio"/>	Disabled
	<input type="radio"/>	<input type="radio"/>	<input type="radio"/>	<input type="radio"/>	<input type="radio"/>	<input type="radio"/>	<input type="radio"/>	<input checked="" type="radio"/>	Enabled (U/S -20%)
If this is enabled, the unit will shut down the generator if the frequency falls below 20% of the nominal frequency.									
Remote start function	<input type="radio"/>	<input checked="" type="radio"/>	<input checked="" type="radio"/>	<input checked="" type="radio"/>	<input type="radio"/>	<input type="radio"/>	<input type="radio"/>	<input type="radio"/>	Remote start
	<input type="radio"/>	<input type="radio"/>	<input type="radio"/>	<input type="radio"/>	<input type="radio"/>	<input type="radio"/>	<input type="radio"/>	<input checked="" type="radio"/>	Simulated mains
Programmable input can be configured to one of the following. <ul style="list-style-type: none"> ◆ Remote start – If the input is active the generator will be started, and stopped if the input is inactive. Mains fail is always active. ◆ Simulated mains – If the input is active the generator will not start in the event of a mains failure. E.G. if the generator is supporting a non 24 hour operation, a 24 hour timer can be used to prevent a mains failure from starting the generator and taking load. 									
Remote start on load (ignore if simulated mains)	<input type="radio"/>	<input checked="" type="radio"/>	<input checked="" type="radio"/>	<input checked="" type="radio"/>	<input checked="" type="radio"/>	<input type="radio"/>	<input type="radio"/>	<input type="radio"/>	Remote start is off load
	<input type="radio"/>	<input type="radio"/>	<input type="radio"/>	<input type="radio"/>	<input type="radio"/>	<input type="radio"/>	<input type="radio"/>	<input checked="" type="radio"/>	Remote start is on load
The remote start input can be configured to one of the following. <ul style="list-style-type: none"> ◆ Remote start is off load – The generator will start and run off load when the remote start input is active. ◆ Remote start is on load – The generator will start, and the load transferred to the generator when the remote start is active. 									

FUNCTIONS AND CONFIGURATION TABLE

Function							I 1	I 2	Value (Default in Bold)
Auxiliary Input 1 Function	<input checked="" type="radio"/>	<input type="radio"/>	<input type="radio"/>	<input type="radio"/>	<input type="radio"/>	<input type="radio"/>	<input type="radio"/>	<input type="radio"/>	Immediate Warning Close on Fault
	<input type="radio"/>	<input type="radio"/>	<input type="radio"/>	<input type="radio"/>	<input type="radio"/>	<input type="radio"/>	<input type="radio"/>	<input checked="" type="radio"/>	Immediate Warning Open on Fault
	<input type="radio"/>	<input type="radio"/>	<input type="radio"/>	<input type="radio"/>	<input type="radio"/>	<input type="radio"/>	<input checked="" type="radio"/>	<input type="radio"/>	Immediate Shutdown Close on Fault
	<input type="radio"/>	<input type="radio"/>	<input type="radio"/>	<input type="radio"/>	<input type="radio"/>	<input type="radio"/>	<input checked="" type="radio"/>	<input checked="" type="radio"/>	Immediate Shutdown Open on Fault
	<input checked="" type="radio"/>	<input type="radio"/>	<input type="radio"/>	<input type="radio"/>	<input type="radio"/>	<input type="radio"/>	<input type="radio"/>	<input type="radio"/>	Delayed Warning Close on Fault
	<input checked="" type="radio"/>	<input type="radio"/>	<input type="radio"/>	<input type="radio"/>	<input type="radio"/>	<input type="radio"/>	<input type="radio"/>	<input checked="" type="radio"/>	Delayed Warning Open on Fault
	<input checked="" type="radio"/>	<input checked="" type="radio"/>	<input type="radio"/>	<input type="radio"/>	<input type="radio"/>	<input type="radio"/>	<input type="radio"/>	<input type="radio"/>	Delayed Shutdown Close on Fault
	<input checked="" type="radio"/>	<input checked="" type="radio"/>	<input checked="" type="radio"/>	<input type="radio"/>	<input type="radio"/>	<input type="radio"/>	<input type="radio"/>	<input type="radio"/>	Delayed Shutdown Open on Fault

Programmable input, can be configured to on of the following

- ◆ Immediate warning close on fault – If the input is activated at any time the unit will alarm and energise the common warning and common alarm output.
- ◆ Immediate warning open on fault – If the input is deactivated at any time the unit will alarm and energise the common warning and common alarm output.
- ◆ Immediate shutdown close on fault – If the input is activated at any time the generator will be shutdown and energise the common warning and common shutdown output. The generator can not be started.
- ◆ Immediate shutdown open on fault – If the input is deactivated at any time the generator will be shutdown and energise the common warning and common shutdown output. The generator can not be started.
- ◆ Delayed warning close on fault – If the input is activated and the saftey time has elapsed the unit will alarm and energise the common warning and common alarm output.
- ◆ Delayed warning open on fault – If the input is deactivated and the saftey time has elapsed the unit will alarm and energise the common warning and common alarm output.
- ◆ Delayed shutdown close on fault – If the input is activated and the saftey time has elapsed the generator will be shutdown and energise the common warning and common shutdown output.
- ◆ Delayed shutdown open on fault – If the input is deactivated and the saftey time has elapsed the generator will be shutdown and energise the common warning and common shutdown output.

Auxiliary Input 2 Function	<input checked="" type="radio"/>	<input type="radio"/>	<input type="radio"/>	<input type="radio"/>	<input checked="" type="radio"/>	<input type="radio"/>	<input type="radio"/>	<input type="radio"/>	Immediate Warning Close on Fault
	<input type="radio"/>	<input type="radio"/>	<input type="radio"/>	<input type="radio"/>	<input type="radio"/>	<input type="radio"/>	<input type="radio"/>	<input checked="" type="radio"/>	Immediate Warning Open on Fault
	<input type="radio"/>	<input type="radio"/>	<input type="radio"/>	<input type="radio"/>	<input type="radio"/>	<input type="radio"/>	<input checked="" type="radio"/>	<input type="radio"/>	Immediate Shutdown Close on Fault
	<input type="radio"/>	<input type="radio"/>	<input type="radio"/>	<input type="radio"/>	<input type="radio"/>	<input type="radio"/>	<input checked="" type="radio"/>	<input checked="" type="radio"/>	Immediate Shutdown Open on Fault
	<input checked="" type="radio"/>	<input type="radio"/>	<input type="radio"/>	<input type="radio"/>	<input type="radio"/>	<input type="radio"/>	<input type="radio"/>	<input type="radio"/>	Delayed Warning Close on Fault
	<input checked="" type="radio"/>	<input type="radio"/>	<input type="radio"/>	<input type="radio"/>	<input type="radio"/>	<input type="radio"/>	<input type="radio"/>	<input checked="" type="radio"/>	Delayed Warning Open on Fault
	<input checked="" type="radio"/>	<input checked="" type="radio"/>	<input type="radio"/>	<input type="radio"/>	<input type="radio"/>	<input type="radio"/>	<input type="radio"/>	<input type="radio"/>	Delayed Shutdown Close on Fault
	<input checked="" type="radio"/>	<input checked="" type="radio"/>	<input checked="" type="radio"/>	<input type="radio"/>	<input type="radio"/>	<input type="radio"/>	<input type="radio"/>	<input type="radio"/>	Delayed Shutdown Open on Fault

Programmable input, can be configured to on of the following

- ◆ Immediate warning close on fault – If the input is activated at any time the unit will alarm and energise the common warning and common alarm output.
- ◆ Immediate warning open on fault – If the input is deactivated at any time the unit will alarm and energise the common warning and common alarm output.
- ◆ Immediate shutdown close on fault – If the input is activated at any time the generator will be shutdown and energise the common warning and common shutdown output. The generator can not be started.
- ◆ Immediate shutdown open on fault – If the input is deactivated at any time the generator will be shutdown and energise the common warning and common shutdown output. The generator can not be started.
- ◆ Delayed warning close on fault – If the input is activated and the saftey time has elapsed the unit will alarm and energise the common warning and common alarm output.
- ◆ Delayed warning open on fault – If the input is deactivated and the saftey time has elapsed the unit will alarm and energise the common warning and common alarm output.
- ◆ Delayed shutdown close on fault – If the input is activated and the saftey time has elapsed the generator will be shutdown and energise the common warning and common shutdown output.
- ◆ Delayed shutdown open on fault – If the input is deactivated and the saftey time has elapsed the generator will be shutdown and energise the common warning and common shutdown output.

FUNCTIONS AND CONFIGURATION TABLE

Function							I 1	I 2	Value (Default in Bold)
Auxiliary Output 1 Function	<input checked="" type="checkbox"/>	<input type="checkbox"/>	<input type="checkbox"/>	<input checked="" type="checkbox"/>	<input type="checkbox"/>	<input type="checkbox"/>	<input type="checkbox"/>	<input type="checkbox"/>	Not used
	<input type="checkbox"/>	<input type="checkbox"/>	<input type="checkbox"/>	<input type="checkbox"/>	<input type="checkbox"/>	<input type="checkbox"/>	<input type="checkbox"/>	<input checked="" type="checkbox"/>	Pre-heat
	<input type="checkbox"/>	<input type="checkbox"/>	<input type="checkbox"/>	<input type="checkbox"/>	<input type="checkbox"/>	<input type="checkbox"/>	<input checked="" type="checkbox"/>	<input type="checkbox"/>	Engine Running
	<input type="checkbox"/>	<input type="checkbox"/>	<input type="checkbox"/>	<input type="checkbox"/>	<input type="checkbox"/>	<input type="checkbox"/>	<input checked="" type="checkbox"/>	<input checked="" type="checkbox"/>	Common Warning
	<input checked="" type="checkbox"/>	<input type="checkbox"/>	<input type="checkbox"/>	<input type="checkbox"/>	<input type="checkbox"/>	<input type="checkbox"/>	<input type="checkbox"/>	<input type="checkbox"/>	Common Shutdown
	<input checked="" type="checkbox"/>	<input type="checkbox"/>	<input type="checkbox"/>	<input type="checkbox"/>	<input type="checkbox"/>	<input type="checkbox"/>	<input type="checkbox"/>	<input checked="" type="checkbox"/>	System in Auto
	<input checked="" type="checkbox"/>	<input checked="" type="checkbox"/>	<input type="checkbox"/>	<input type="checkbox"/>	<input type="checkbox"/>	<input type="checkbox"/>	<input type="checkbox"/>	<input type="checkbox"/>	Common Alarm
	<input checked="" type="checkbox"/>	<input checked="" type="checkbox"/>	<input checked="" type="checkbox"/>	<input checked="" type="checkbox"/>	<input checked="" type="checkbox"/>	<input checked="" type="checkbox"/>	<input checked="" type="checkbox"/>	<input checked="" type="checkbox"/>	Energise to Stop

Programmable output can be configured to one of the following.

- ◆ Pre-heat. - The output is energised for the period of pre-heat time prior to cranking, and between the cranking attempts.
- ◆ Engine Running. - The output is active after the safety timer has elapsed.
- ◆ Common warning. - The output is active if there are any warning alarm active.
- ◆ Common shutdown. - The output is active if there are any shutdown alarms active.
- ◆ System in auto. - The output is active when the system is in automatic mode.
- ◆ Common Alarm. - The output is active if there is any alarm condition.
- ◆ Energise to stop. - The output is energised when the engine is required to stop (normal or fault conditions), and will remain energised for the period of the Energise To Stop Timer, to ensure the engine has come to a complete stop.

Auxiliary Output 2 Function	<input checked="" type="checkbox"/>	<input type="checkbox"/>	<input type="checkbox"/>	<input checked="" type="checkbox"/>	<input checked="" type="checkbox"/>	<input type="checkbox"/>	<input type="checkbox"/>	<input type="checkbox"/>	Not used
	<input type="checkbox"/>	<input type="checkbox"/>	<input type="checkbox"/>	<input type="checkbox"/>	<input type="checkbox"/>	<input type="checkbox"/>	<input type="checkbox"/>	<input checked="" type="checkbox"/>	Pre-heat
	<input type="checkbox"/>	<input type="checkbox"/>	<input type="checkbox"/>	<input type="checkbox"/>	<input type="checkbox"/>	<input type="checkbox"/>	<input checked="" type="checkbox"/>	<input type="checkbox"/>	Engine Running
	<input type="checkbox"/>	<input type="checkbox"/>	<input type="checkbox"/>	<input type="checkbox"/>	<input type="checkbox"/>	<input type="checkbox"/>	<input checked="" type="checkbox"/>	<input checked="" type="checkbox"/>	Common Warning
	<input checked="" type="checkbox"/>	<input type="checkbox"/>	<input type="checkbox"/>	<input type="checkbox"/>	<input type="checkbox"/>	<input type="checkbox"/>	<input type="checkbox"/>	<input type="checkbox"/>	Common Shutdown
	<input checked="" type="checkbox"/>	<input type="checkbox"/>	<input type="checkbox"/>	<input type="checkbox"/>	<input type="checkbox"/>	<input type="checkbox"/>	<input type="checkbox"/>	<input checked="" type="checkbox"/>	System in Auto
	<input checked="" type="checkbox"/>	<input checked="" type="checkbox"/>	<input type="checkbox"/>	<input type="checkbox"/>	<input type="checkbox"/>	<input type="checkbox"/>	<input type="checkbox"/>	<input type="checkbox"/>	Common Alarm
	<input checked="" type="checkbox"/>	<input checked="" type="checkbox"/>	<input checked="" type="checkbox"/>	<input checked="" type="checkbox"/>	<input checked="" type="checkbox"/>	<input checked="" type="checkbox"/>	<input checked="" type="checkbox"/>	<input checked="" type="checkbox"/>	Energise to Stop

Programmable output can be configured to one of the following.

- ◆ Pre-heat. - The output is energised for the period of pre-heat time prior to cranking, and between the cranking attempts.
- ◆ Engine Running. - The output is active after the safety timer has elapsed.
- ◆ Common warning. - The output is active if there are any warning alarm active.
- ◆ Common shutdown. - The output is active if there are any shutdown alarms active.
- ◆ System in auto. - The output is active when the system is in automatic mode.
- ◆ Common Alarm. - The output is active if there is any alarm condition.
- ◆ Energise to stop. - The output is energised when the engine is required to stop (normal or fault conditions), and will remain energised for the period of the Energise To Stop Timer, to ensure the engine has come to a complete stop.

Mains Under Voltage (Trip / Return)	<input checked="" type="checkbox"/>	<input type="checkbox"/>	<input checked="" type="checkbox"/>	<input type="checkbox"/>	<input type="checkbox"/>	<input type="checkbox"/>	<input type="checkbox"/>	<input type="checkbox"/>	60V / 70V
	<input type="checkbox"/>	<input type="checkbox"/>	<input type="checkbox"/>	<input type="checkbox"/>	<input type="checkbox"/>	<input type="checkbox"/>	<input type="checkbox"/>	<input checked="" type="checkbox"/>	70V / 80V
	<input type="checkbox"/>	<input type="checkbox"/>	<input type="checkbox"/>	<input type="checkbox"/>	<input type="checkbox"/>	<input type="checkbox"/>	<input checked="" type="checkbox"/>	<input type="checkbox"/>	80V / 90V
	<input type="checkbox"/>	<input type="checkbox"/>	<input type="checkbox"/>	<input type="checkbox"/>	<input type="checkbox"/>	<input type="checkbox"/>	<input checked="" type="checkbox"/>	<input checked="" type="checkbox"/>	90V / 100V
	<input checked="" type="checkbox"/>	<input type="checkbox"/>	<input type="checkbox"/>	<input type="checkbox"/>	<input type="checkbox"/>	<input type="checkbox"/>	<input type="checkbox"/>	<input type="checkbox"/>	120V / 140V
	<input checked="" type="checkbox"/>	<input type="checkbox"/>	<input type="checkbox"/>	<input type="checkbox"/>	<input type="checkbox"/>	<input type="checkbox"/>	<input type="checkbox"/>	<input checked="" type="checkbox"/>	140V / 160V
	<input checked="" type="checkbox"/>	<input checked="" type="checkbox"/>	<input type="checkbox"/>	<input type="checkbox"/>	<input type="checkbox"/>	<input type="checkbox"/>	<input type="checkbox"/>	<input type="checkbox"/>	160V / 180V
	<input checked="" type="checkbox"/>	<input checked="" type="checkbox"/>	<input checked="" type="checkbox"/>	<input checked="" type="checkbox"/>	<input checked="" type="checkbox"/>	<input checked="" type="checkbox"/>	<input checked="" type="checkbox"/>	<input checked="" type="checkbox"/>	180V / 200V
	<input checked="" type="checkbox"/>	<input checked="" type="checkbox"/>	<input checked="" type="checkbox"/>	<input checked="" type="checkbox"/>	<input checked="" type="checkbox"/>	<input checked="" type="checkbox"/>	<input checked="" type="checkbox"/>	<input checked="" type="checkbox"/>	180V / 200V

If for example 180/200 is selected the generator will be started and the load transferred if any phase falls below 180V with respect to the neutral for the duration of the delay start timer. The load will be transferred back to mains when the mains voltage returns to 200V or higher for the duration of the mains return timer. (The system must be in Auto)

4 TERMINAL DESCRIPTION

PIN No	DESCRIPTION	CABLE SIZE	NOTES
1	DC Plant Supply Input (-ve)	1.0mm	Connected to plant battery negative
2	DC Plant Supply Input (+ve)	1.0mm	Connected to plant battery positive (Recommended Fuse 2A)
3	Fuel relay Output	1.0mm	Used to operate the fuel relay.
4	Start relay Output	1.0mm	Used to operate the cranking relay.
5	Auxiliary Output relay 1	1.0mm	Configurable output.
6	Auxiliary Output relay 2	1.0mm	Configurable output.
7	Charge Fail Input/ Excitation Output	1.0mm	Must NOT be connected to plant supply negative if not used.
8	Low Oil Pressure Input	0.5mm	Switch to negative.
9	High Engine Temp Input	0.5mm	Switch to negative.
10	Auxiliary Input 1	0.5mm	Switch to negative.
11	Auxiliary Input 2	0.5mm	Switch to negative.
12	Remote Start Input	0.5mm	Switch to negative.
13	Mains loading Relay Normally Open contact	1.0mm	Used to close the mains contactor / breaker
14	Generator loading Relay Normally Open contact	1.0mm	Used to close the generator contactor / breaker
15	Functional Earth	1.0mm	Connect to a good clean earth point
16	Mains L1 Voltage Monitoring Input	1.0mm	Connect to Mains L1 supply (AC) (Recommend 2A Fuse Max.)
17	Mains L2 Voltage Monitoring Input	1.0mm	Connect to Mains L1 supply (AC) (Recommend 2A Fuse Max.)
18	Mains L3 Voltage Monitoring Input	1.0mm	Connect to Mains L1 supply (AC) (Recommend 2A Fuse Max.)
19	Mains N Voltage Monitoring Input	1.0mm	Connect to Mains N supply (AC)
20	Alternator Input L1	1.0mm	Do not connect if not used. (2A Fuse)
21	Alternator Input N	1.0mm	Do not connect if not used.

 **NOTE:-** For single phase mains monitoring the neutral should be connected to terminal 19, L1 should be connected to terminals 16,17 and 18.

 **NOTE:-** For two phase mains monitoring the L2 should be connected to terminal 19, L1 should be connected to terminals 16,17 and 18. The voltage between the two phases must not exceed 305 Volts.

 **NOTE:-** All the outputs are solid state, rated at 1.2 Amps 8 Volts to 35 Volts DC, and switch to battery negative when active.

5 SPECIFICATION

DC Supply:	8 Volts to 35 Volts DC Continuous.
Cranking Dropouts:	Able to survive 0 Volts for 50 mS, providing supply was at least 10 V before dropout and supply recovers to 5 Volts. This is achieved without the need for internal batteries.
Max. Current:	Operating 50mA Standby 10mA
Alternator Input Range:	75 Volts (ph-N) to 277 Volts (ph-N) AC (+20%)
Mains Input Voltage	15 – 277 Volts (ph-N) AC (+20%)
Alternator Input Frequency:	50 - 60 Hz at rated engine speed (Minimum: 75V AC Ph-N) (Crank Disconnect from 15V Ph-N @ 20Hz) Overspeed +14% (+24% overshoot) Underspeed –20%
Mains Frequency	50 – 60 Hz
Start Output:	1.2 Amp DC at supply voltage.
Fuel Output:	1.2 Amp DC at supply voltage.
Auxiliary Outputs:	1.2 Amp DC at supply voltage.
Dimensions:	125mm x 165mm x 28 mm
Charge Fail:	12 Volts = 8 Volts CF 24 Volts = 16 Volts CF
Operating Temperature Range:	-30°C to + 70°C
Applicable Standards	Compliant with BS EN 60950 Low Voltage Directive Compliant with BS EN 50081-2: 1992 EMC Directive Compliant with BS EN 61000-6-4: 2000 EMC Directive  Compliance to European Legislation



Registered Component for USA & Canada

Deep Sea Electronics plc reserve the right to change specification without notice.

6 SOLID STATE OUTPUTS

DSE's utilisation of Solid State Outputs gives many advantages, the main points being:

- ◆ No Moving Parts
- ◆ Fully Overload / Short Circuit Protected.
- ◆ Smaller dimensions hence lighter, thinner and cheaper than conventional relays.
- ◆ Less power required making them far more reliable.

The main difference from conventional outputs is that solid state outputs switch to negative (-ve) when active. This type of output is normally used with an automotive or plug in relay.

TYPICAL CONNECTIONS

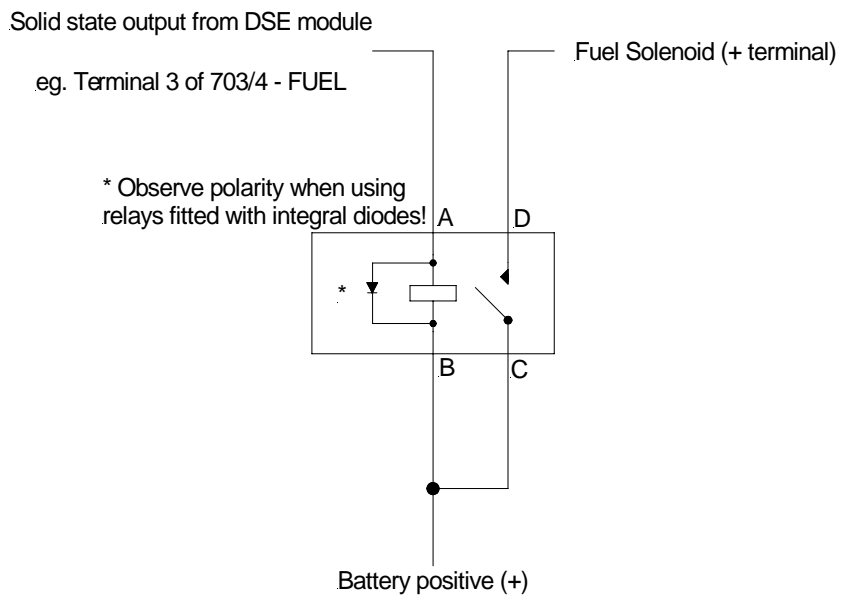

	Solid State Output from DSE Module Pin	Automotive relay Pin	8 Pin Plugin relay	Function
A	3	86	7	Fuel Output
B		85	2	To Positive supply via fuse
C		30	1	To Positive supply via fuse
D		87	3	To Fuel Solenoid

Example of relay pins connected to DSE solid state output to drive a fuel solenoid.
See overleaf for overall typical wiring diagram

NOTE:- The **Close Mains Relay** should be **NORMALLY CLOSED** when de-energised for fail safe reasons. Should the DC supply fail the mains will always be available. The output from the DSE solid state output when energised will **OPEN** the relay therefore isolating the mains supply.

7 DIMENSIONS

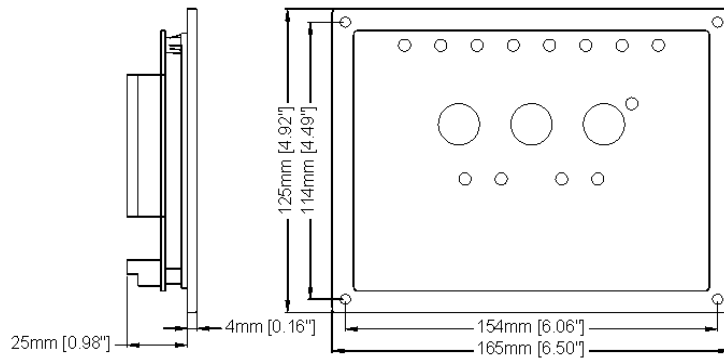

Dimensions:
165mm x 125mm x 29mm
(6.5" x 4.9" x 1.2")

Panel cutout:
149mm x 109mm
(5.9" x 4.3")

Mounting Method:
4 x 4.2mm diameter holes suitable for M4 screws.

8 TYPICAL CONNECTIONS

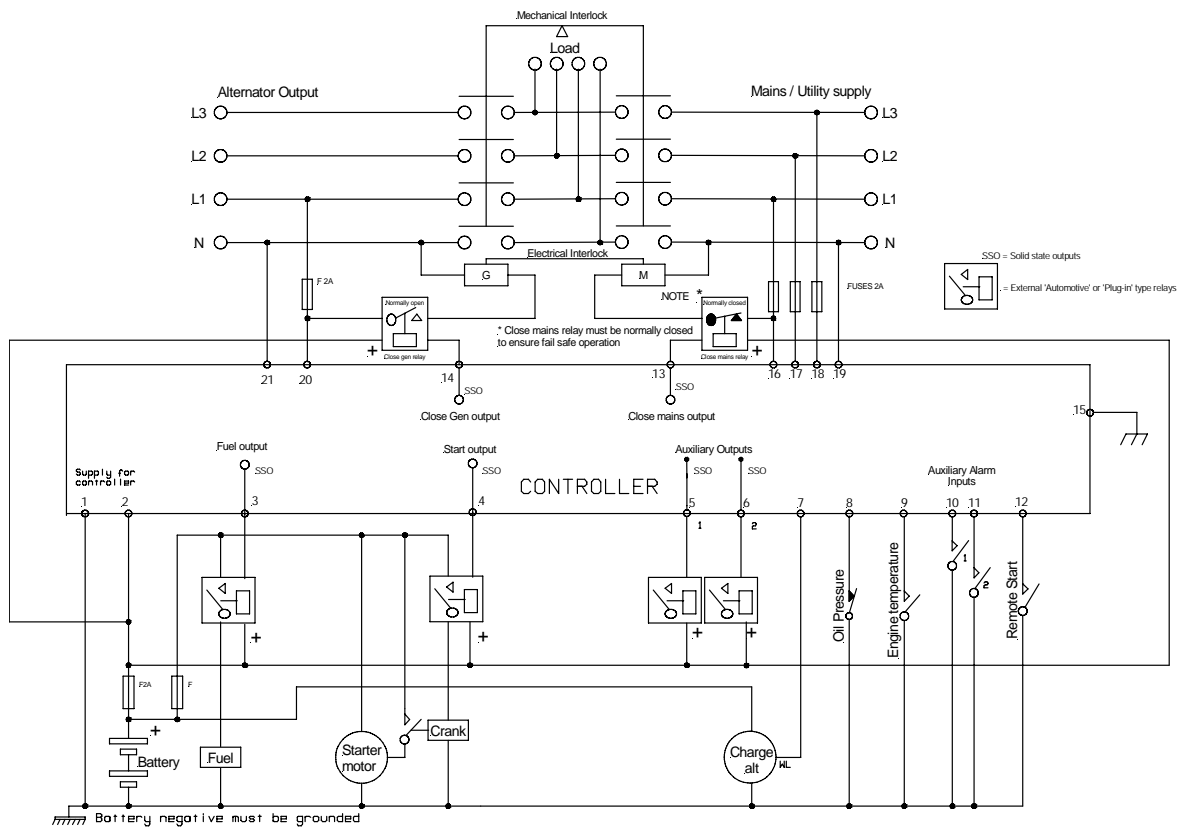

Terminals suitable for 22-16 awg (0.6mm²-1.3mm²) field wiring
Tightening Torque = 0.8N-m (7lb-in)